

GUANGZHOU MICRON VENDING TECHNOLOGY CO., LTD.

2022 | User Manual

Click  **Youtube links** to watch the videos



TOGETHER, LET'S STEP INTO THE NEW ERA OF UNMANNED RETAIL~

Catalogue & User Manual download: www.micronvending.com/en-download-vending-machine-catalog.html

CONTENTS

Part I: Machine Hardware & System [Page 1~4]

Part II: Fast setup - 4 steps [Page 5~15]

2.1 Connect the machine to WIFI, or insert data SIM card. [Page 5~11]

2.2 Create product data base in the system. [Page 12~13]

2.3 Machine product set up. [Page 14]

2.4 Fill the machine. [Page 15]

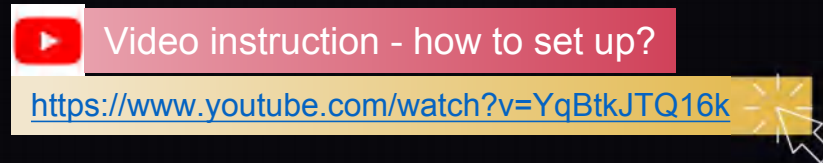

CONTENTS

Part III: Machine basic settings [Page 16~30]

3.1 How to set cooling temperature with temp. controller [Page 16]

3.2 How to set currency symbol of selling price & set payment system [Page 17~20]

3.3 How to set the time of entering advertisement page [Page 21~23]

3.4 How to hide status bar [Page 24~25]

3.5 How to save coins to the coin machine [Page 26]

3.6 How to check the balance amount of coins [Page 27]

3.7 How to amend the Capacity of goods trays [Page 28]

3.8 How to set product shelf life date (Expiration) & warning[Page 29~30]

CONTENTS

Part IV: Features dictionary [Page 31~61]

4.1 How to upload Advertisement [Page 31~35]

4.2 How to upload LOGO/Service Tel. to the machine/server [Page 36~38]

4.3 How to edit Machine info. [Page 39~41]

4.4 How to set Sub account for your team members [Page 42~45]

4.5 How to set Sub account for your customers [Page 46~49]

4.6 How to use Member manage [Page 50~52]

4.7 How to check Real time inventory [Page 53~54]

4.8 How to check Orders & Sales Data [Page 55~57]

4.9 How to check Replenish record [Page 58~61]

Part V: Machine installation [Page 62~68]

Part I: Machine introduction



◆ Goods Tray Option

- Spiral racks
- Direct Push
- Conveyor belt

◆ Payment System Option

- Bill validator
- Coin mech
- Card reader
- E-wallet (upon availability)

◆ Smart Vending System

□ Optional features:

- Elevator
- Infrared drop sensor
- Receipt printer

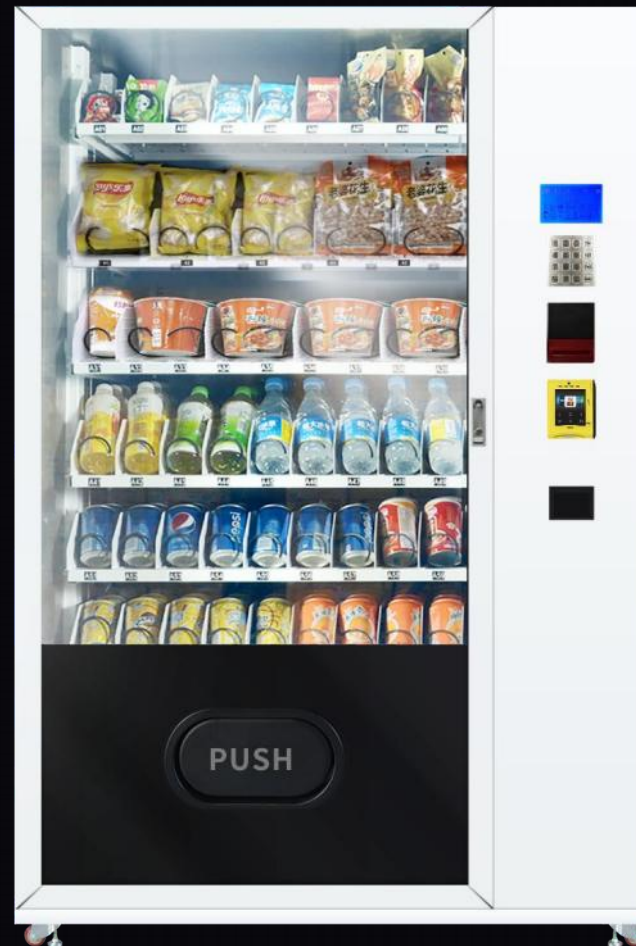

Model#: WM0-W

※ 5" LCD screen + Keypad

※ Internet: WIFI/3G, 4G SIM Card

※ Android OS 5.1

※ ROM 8G / RAM 2G

※ Standard protocol: MDB/RS232

※ Standard variety: 6 Floors * 9 Slots

※ Extra storage shelves

※ Cooling System: 4~20°C

※ 2-Layer tempered glass door

※ 24V Electric defogging

※ LED Lighting stripes

※ Anti-theft design

※ Dimension: W116 × D83 × H194cm

Part I: Management system



1. System Login

1.1 Login link [for Smart phone]

<https://moperator.tech.weimi24.com>

1.2 Login link [for Computer]

<https://operator.tech.weimi24.com/>

1.3 Login

Input the User name and Password

 How to upload/change the LOGO?

<https://www.youtube.com/watch?v=W6jyQSCwHqI>

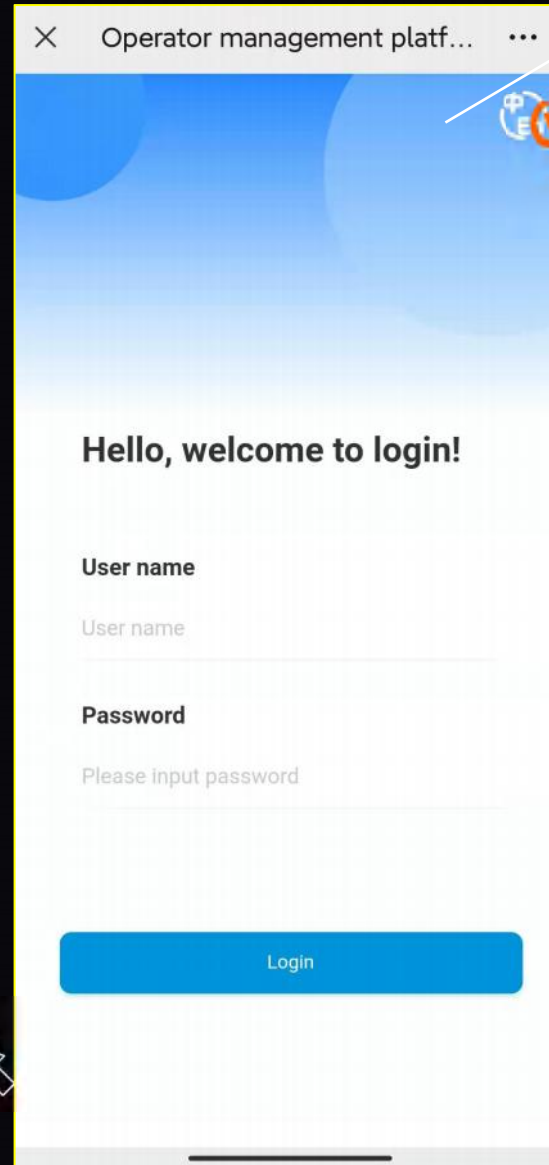

Mobile phone Login page

Switch language

Computer Login page

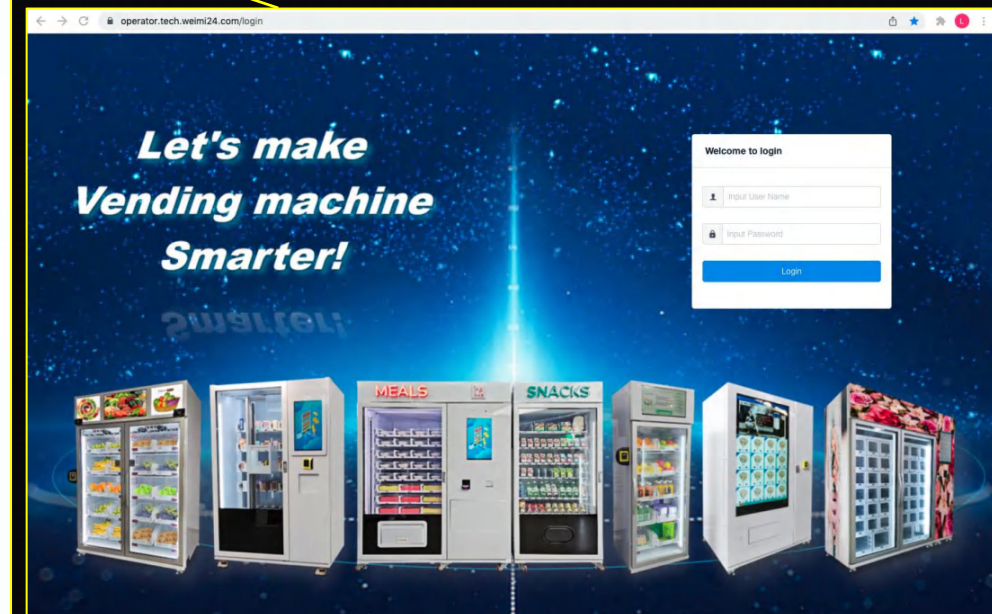

Part I: Management system



2. Smart phone system

2.1 Device Management

2.2 Data Center

2.3 Order Center

2.4 Goods Management

2.5 *Energy Management

(Not available for some models)

2.6 Replanish Management

2.7 Monitor Center

*Follow  to switch language and change password

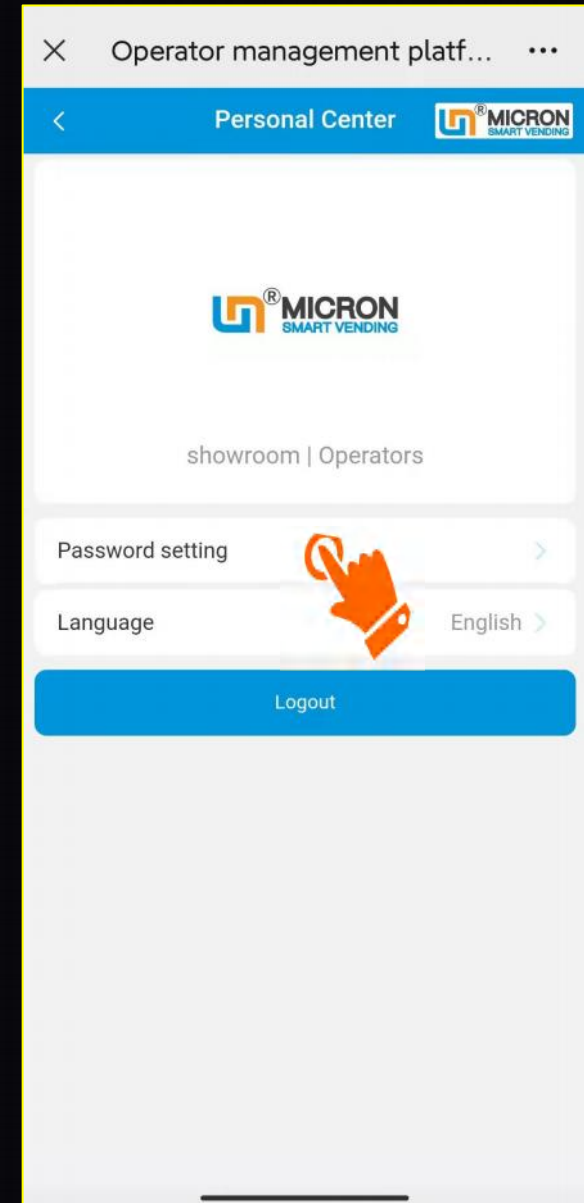
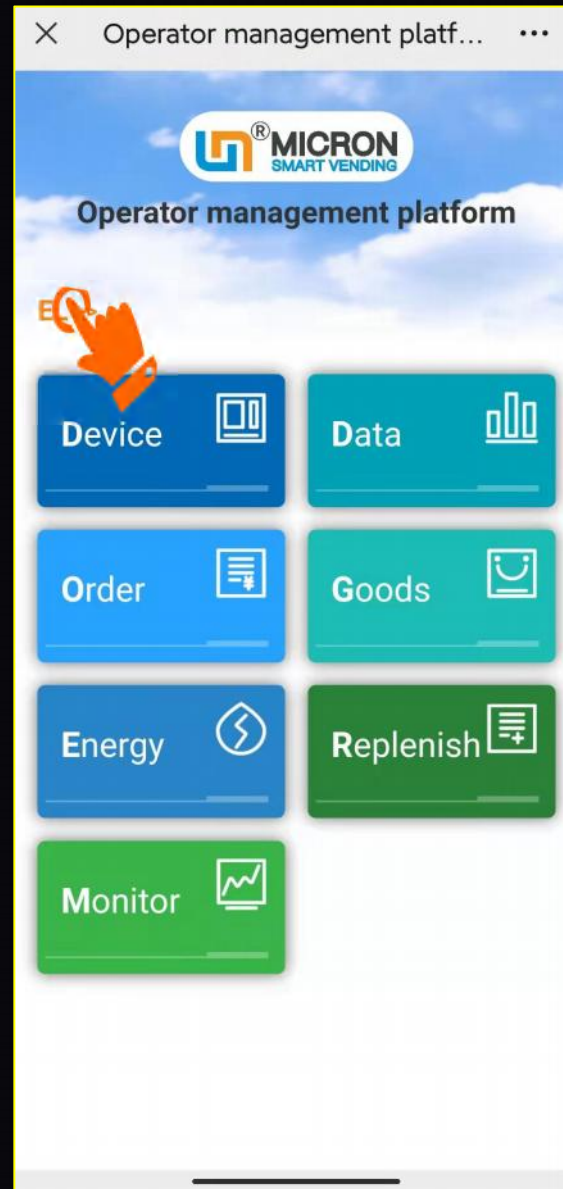

Part I: Management system



3. Computer (PC) system

3.1 Operation Center

This module manages: Goods/Machine/Advertising/Order/Replenishment

3.2 Monitoring Center

This module monitors the status of the machines: Online/Fault/Stockout/Abnormal; And see SIM Card and energy consumption

3.3 Data Center

This module, you can check the Sale report/trend/statistics/ranking

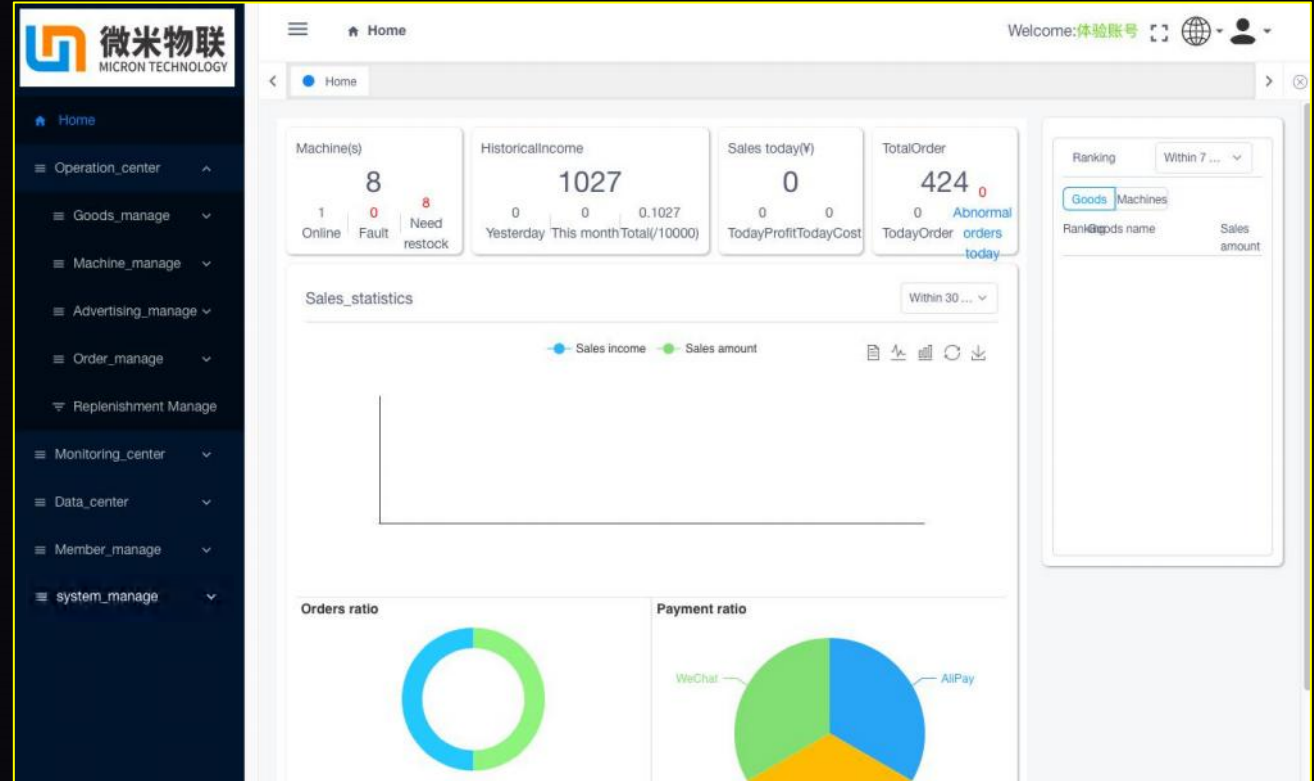

3.4 Member manage

This module manages the Member info, and funds

3.5 System manage

This module manages Operator/IC card/Role/User

Part II: Fast setup - Step 1



Video instruction

<https://www.youtube.com/watch?v=YqBtkJTQ16k>

2.1.1 WIFI Connection (From machine LCD screen)

Connect a mouse to the USB port of the Android mainboard

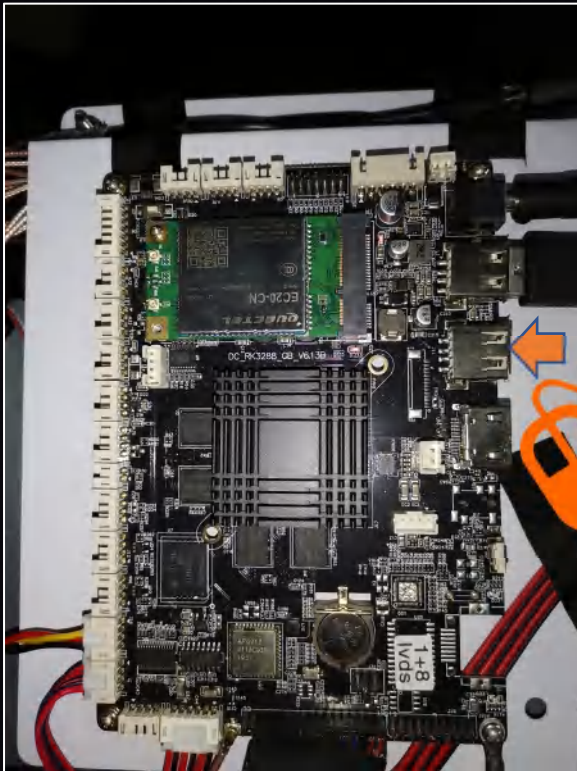

Turn on Android



① Move the pointer to the top left corner of screen, long press the left mouse button for a few seconds

When there is no network connection

① or Single click here

Home 177s

Cash RM 0.00 Refund To Pay

Settings

Wifi

② Connect the WIFI

Part II: Fast setup - Step 1



2.1.2 Enter Vending APP

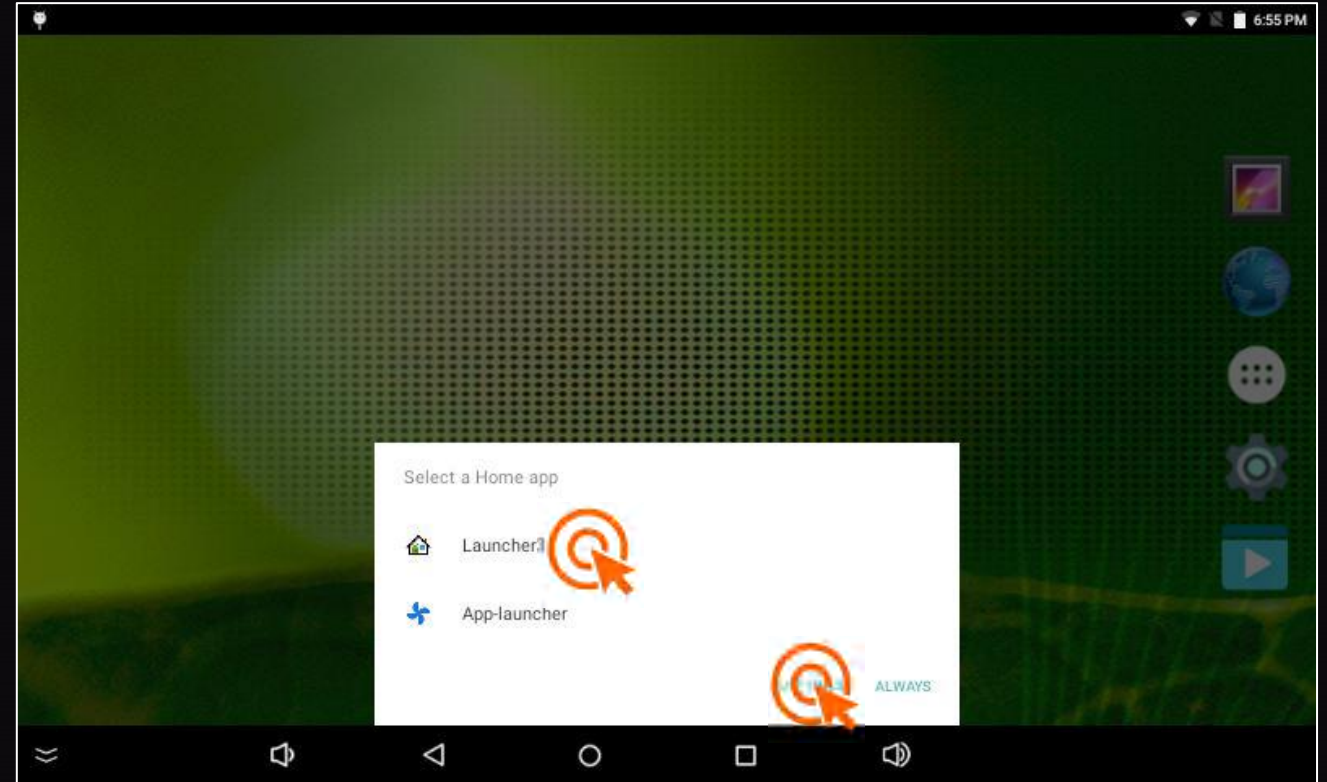
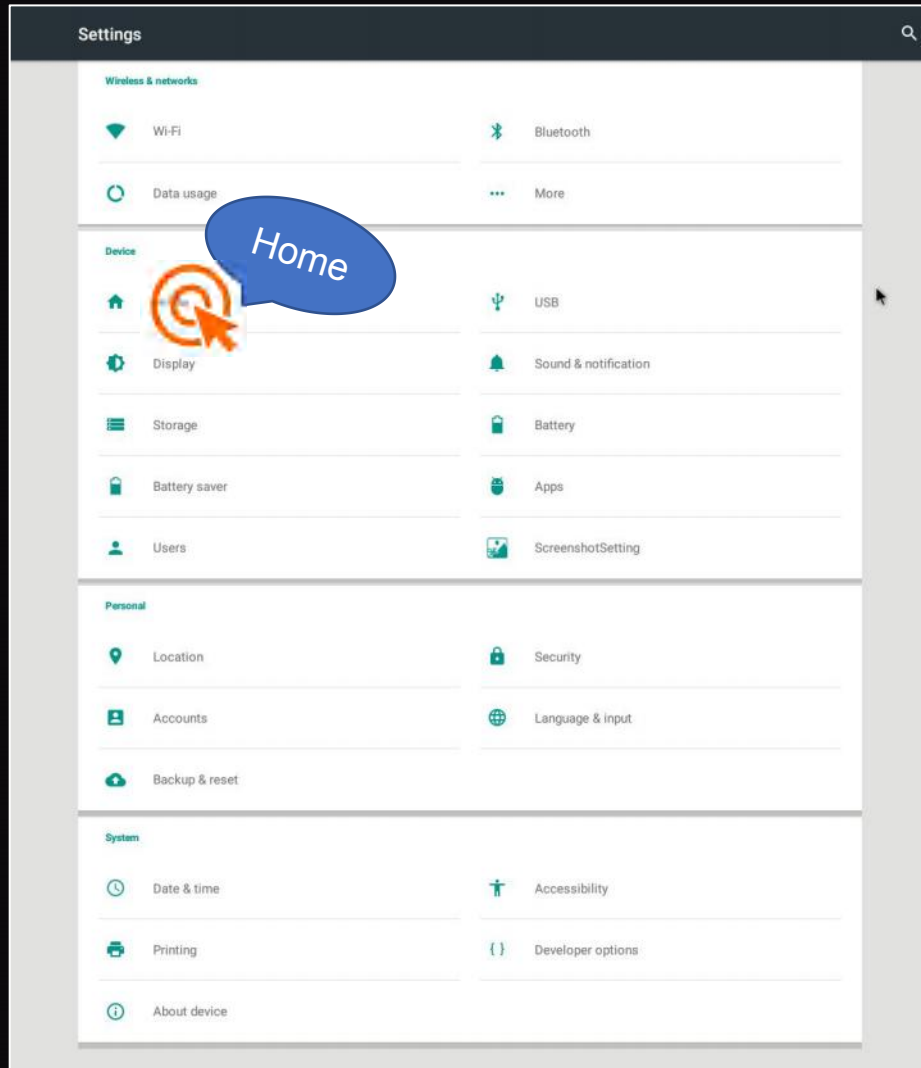

※ **Testing stage: Select Launcher3**

※ **After finished all settings: Select APP-Launcher (This step is very important!!!)**

To make sure it will enter into the Vending App automatically.

Part II: Fast setup - Step 1



2.1.2 Enter Vending APP

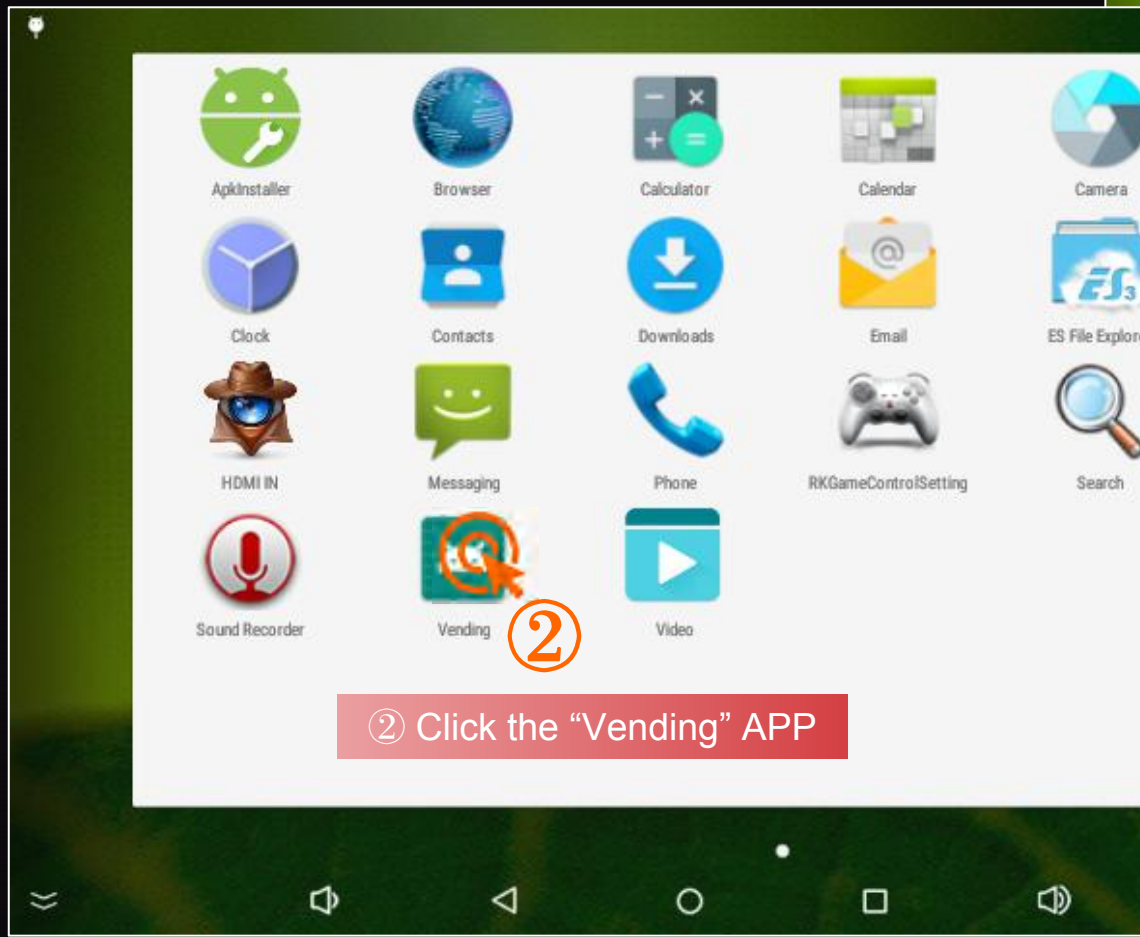
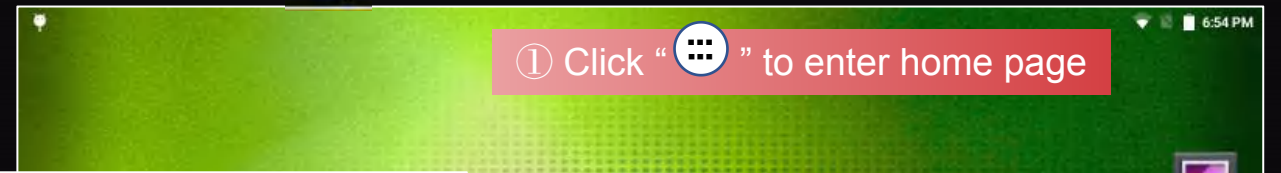

MICRON 技术部测试 V2.0.19 Device code: 61260026

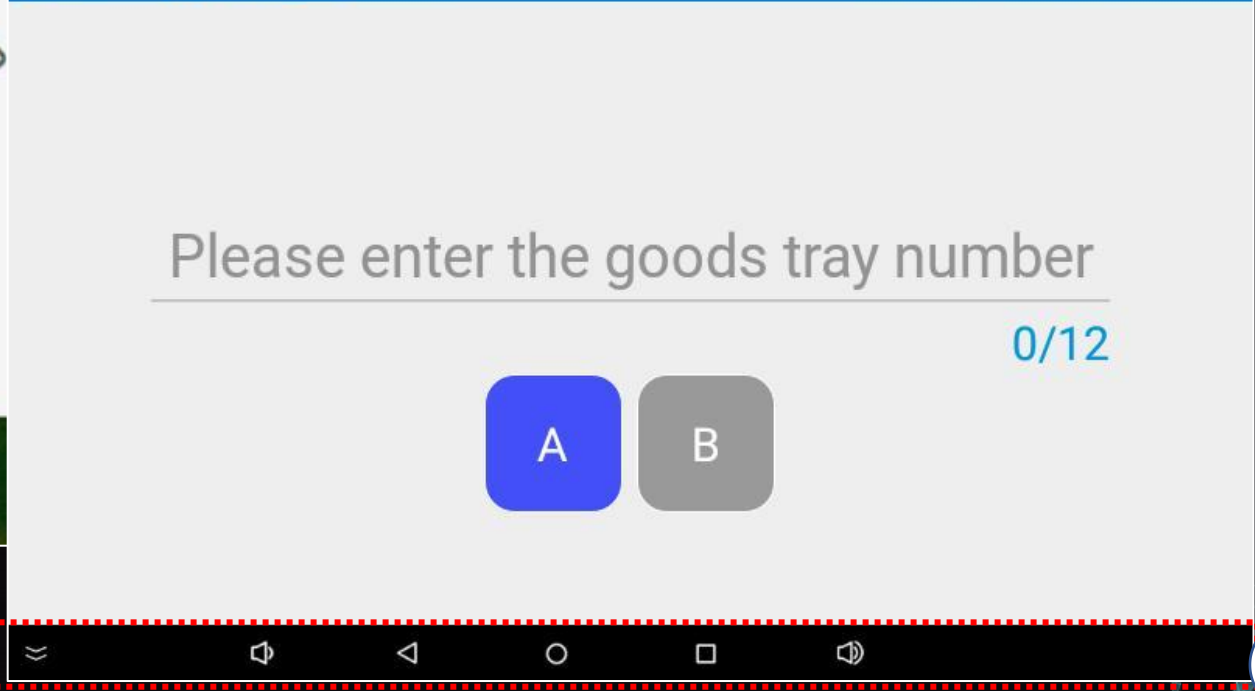

We call this as "Status bar"
How to display or hide it? refer to next page

Part II: Fast setup - Step 1



Tips: How to display/hide the status bar

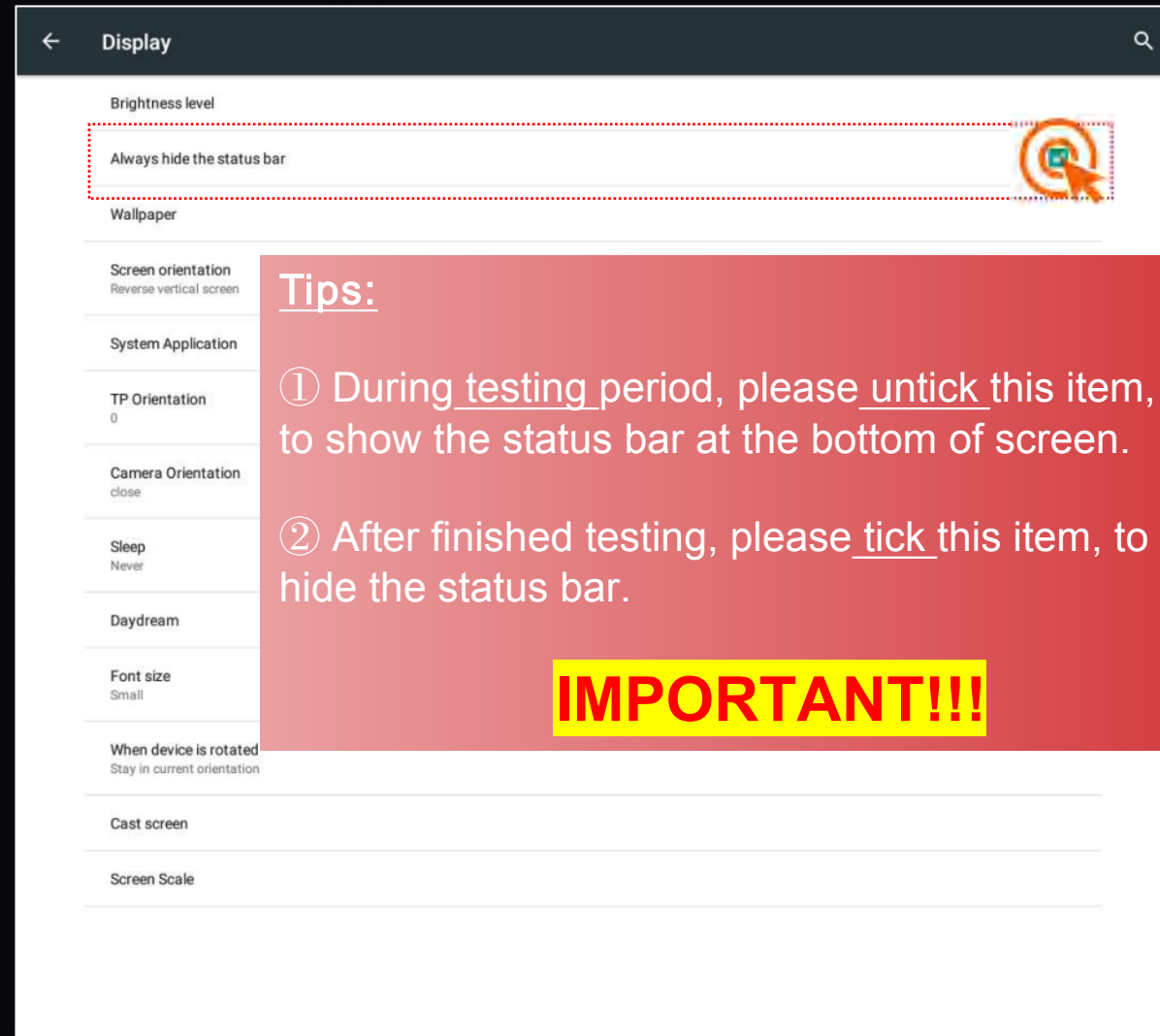
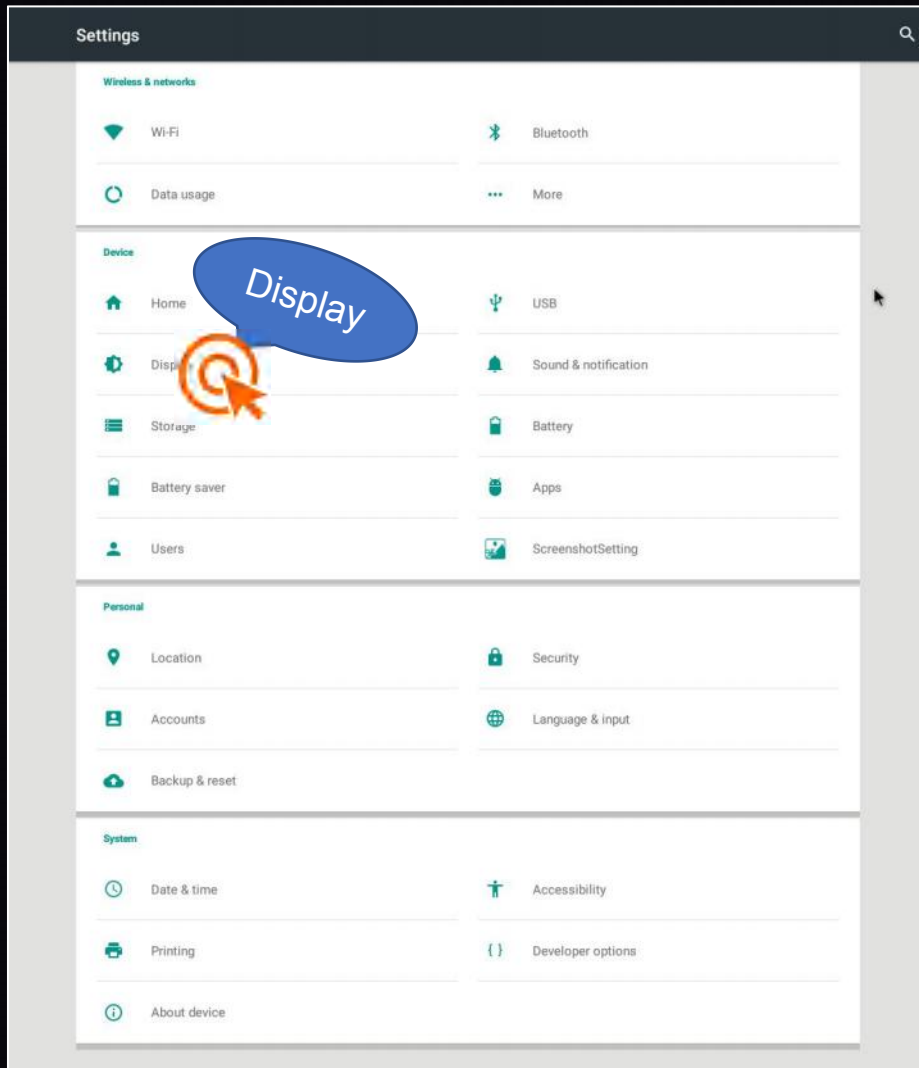

Part II: Fast setup - Step 1



2.1.3 SIM Card (3G/4G)

In case WIFI is not available, you can insert a data SIM card.

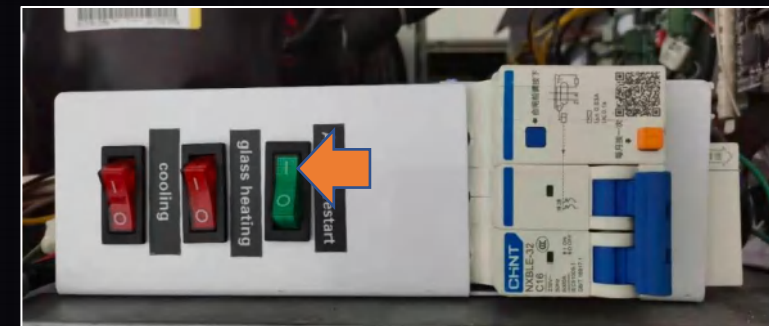
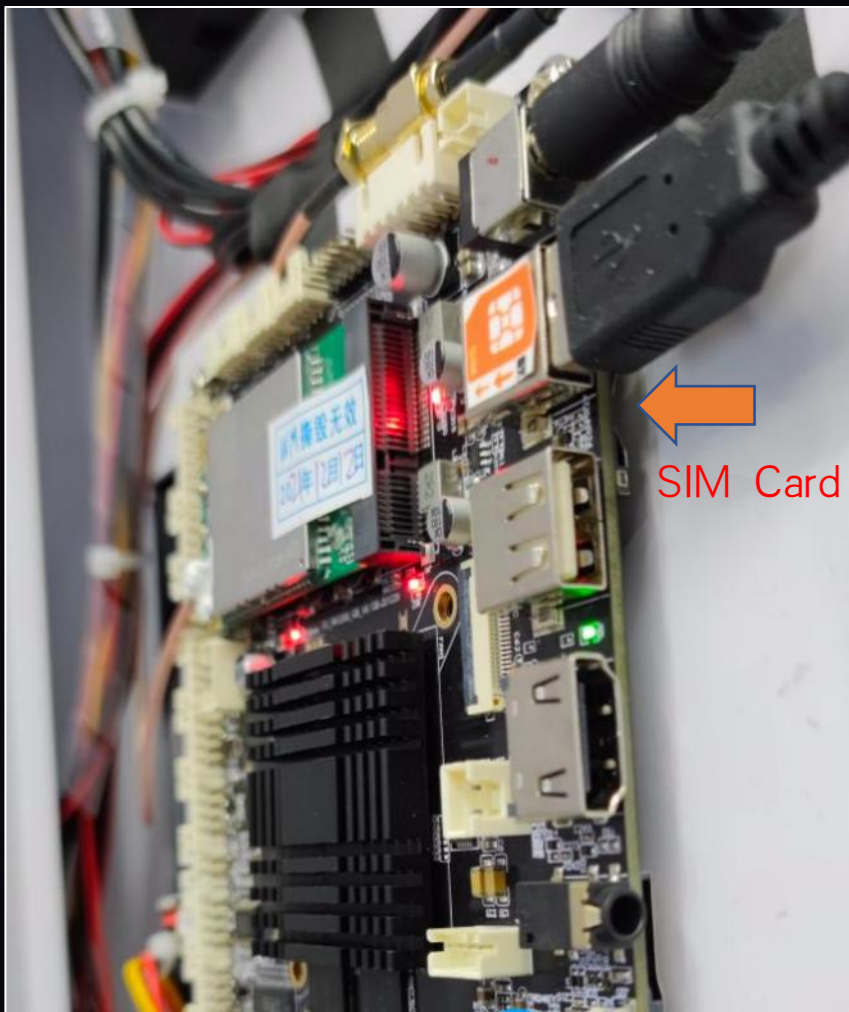

The Android mainboard is installed at the back side of the screen. Insert the 3G/4G data SIM card into the card slot correctly as per the card direction guide sticker.

Restart Android (Green button).

Some SIM cards can access to internet automatically, while some can't, then need to set APN.

Part II: Fast setup - Step 1



How to set APN?

<https://www.youtube.com/watch?v=ByIPLZGbuUw>

2.1.3 SIM Card (3G/4G)

If the data SIM card can access to internet, then ignore this step!

If the SIM card can't access to internet, please follow this step to set APN (Access Point Names).

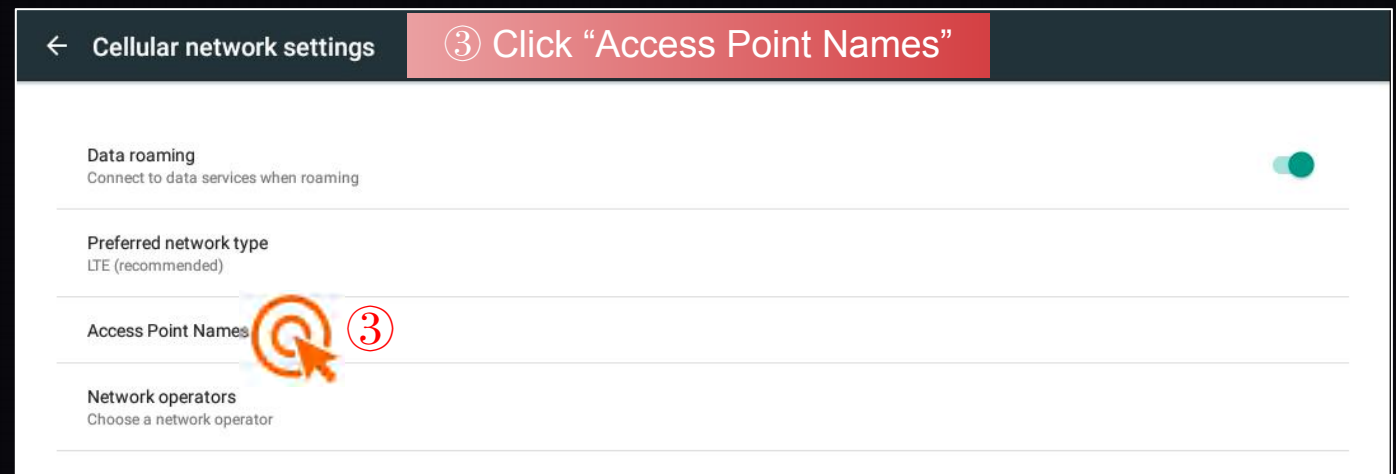
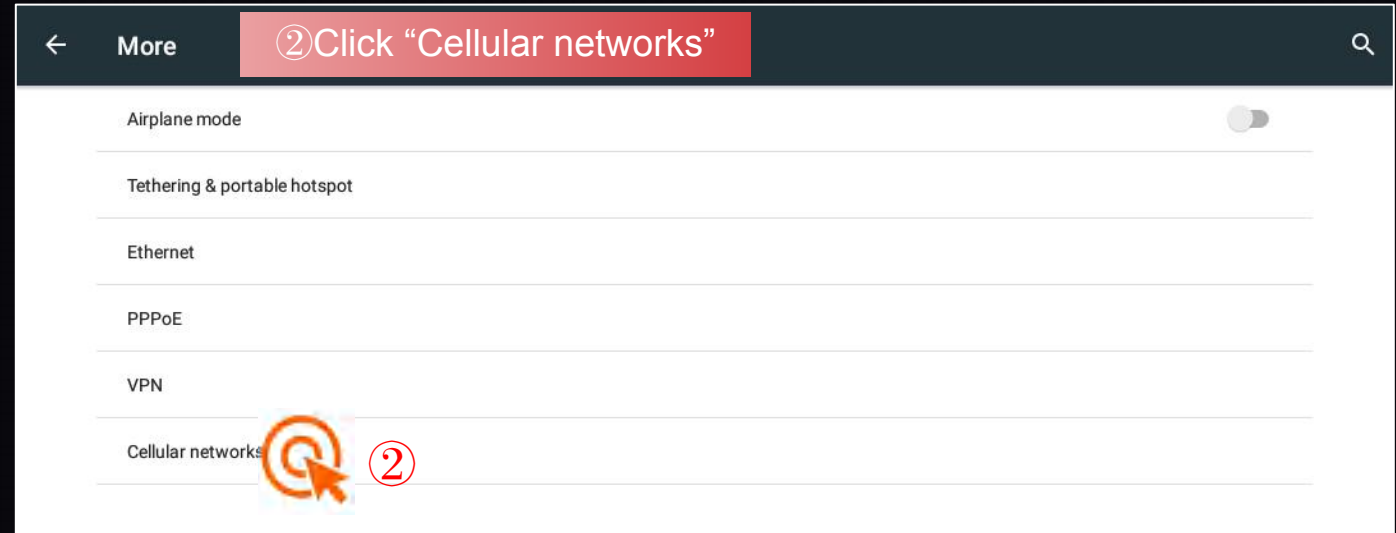
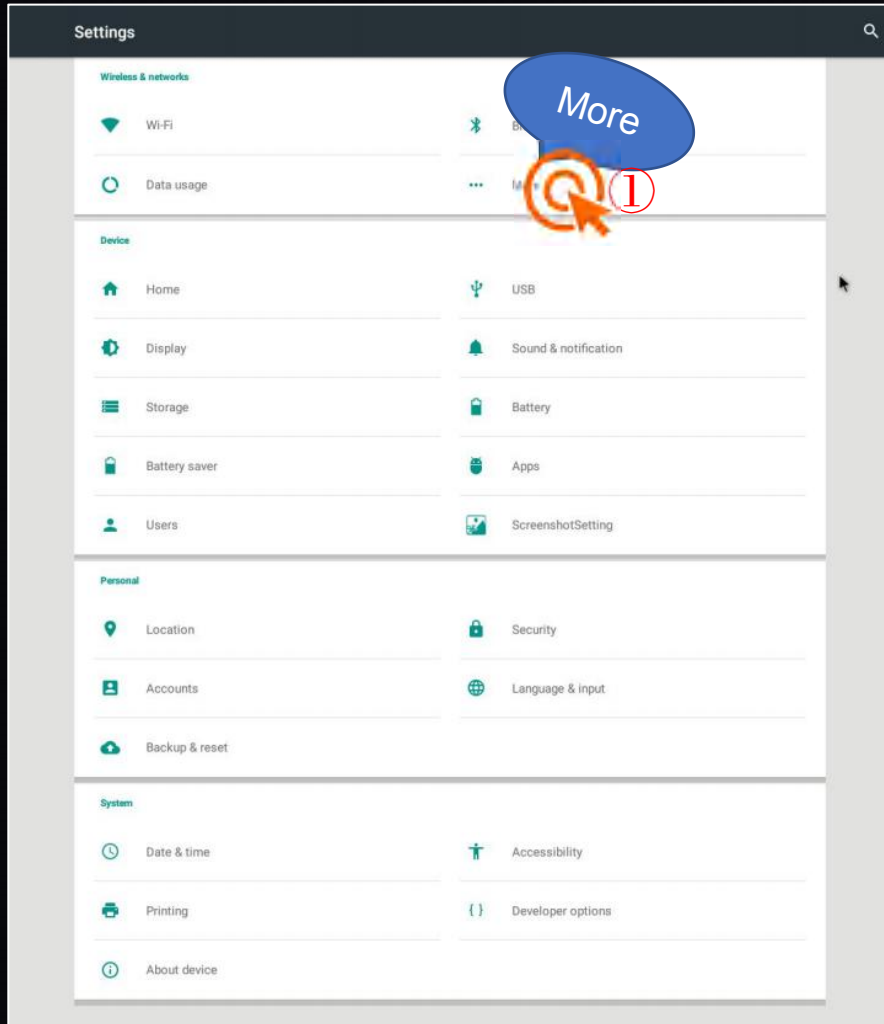

Part II: Fast setup - Step 1



2.1.3 SIM Card (3G/4G) – Set APN

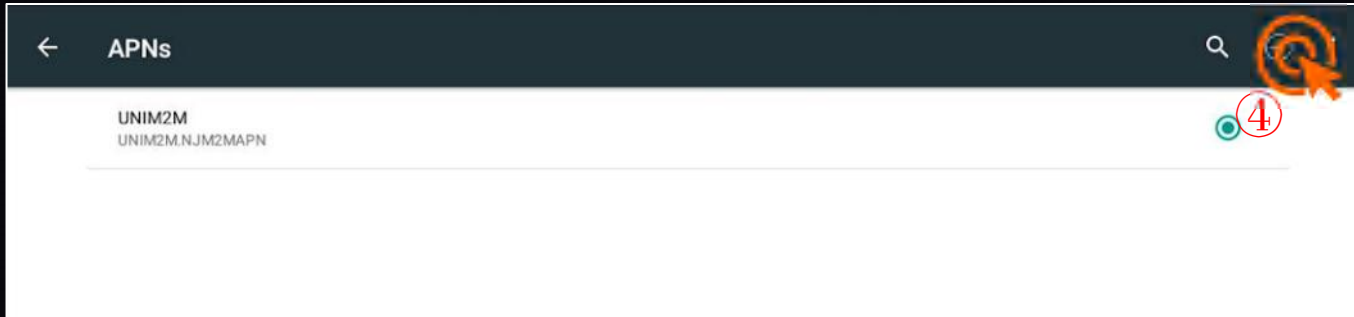

④ Click the “+” on the top right corner to create a APN;

⑤ Usually the mainboard can verify and show the MCC/MNC automatically. You only need to fill in the Name and APN. “Name” -- you can fill in whatever you like; “APN”-- you need to check with the SIM card provider or maybe you can find it from the internet.

⑥ Click the “⋮” on the top right corner to save APN; And then wait for the network connection, which may take 1~2 minutes.

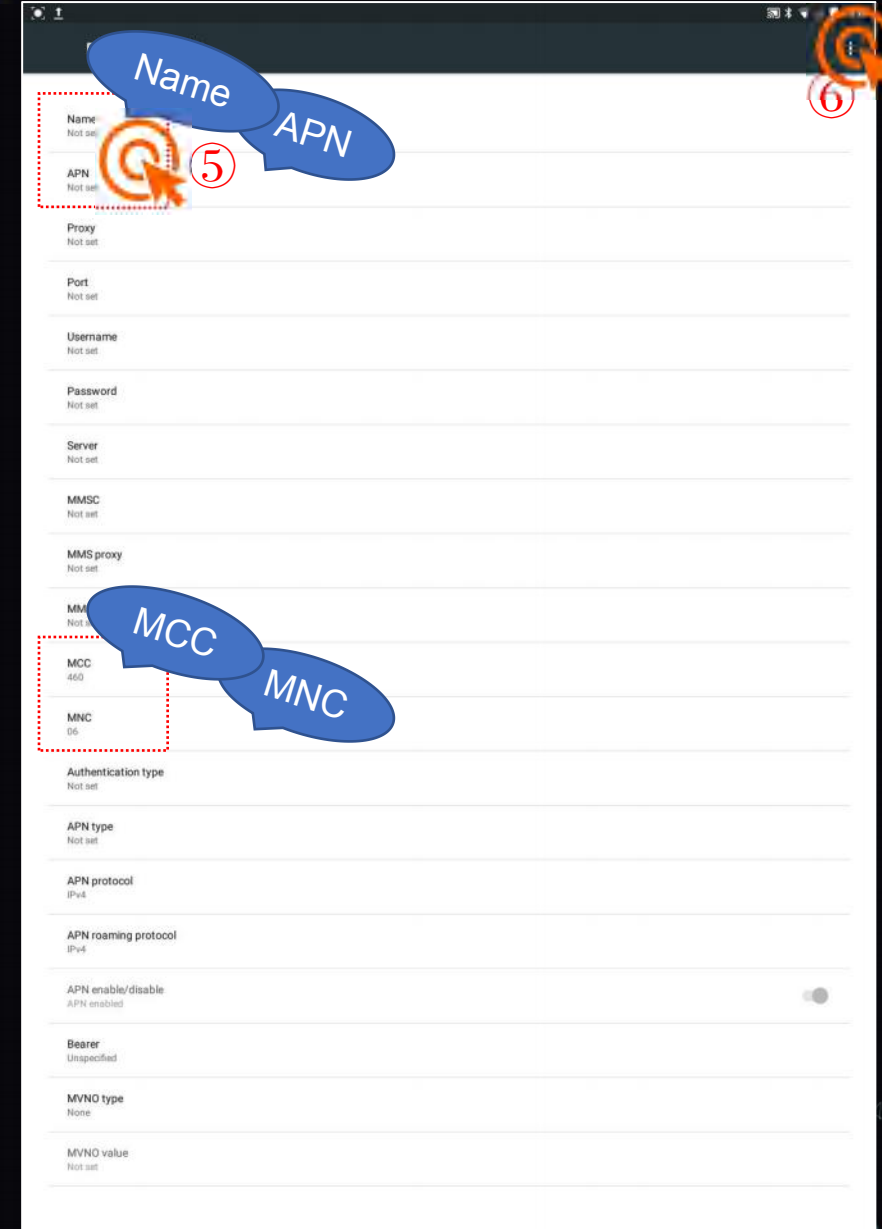

Part II: Fast setup - Step 2



2.2 Create product data base

Login management system by phone

<https://moperator.tech.weimi24.com>

Remark:

- ※ User name and Password will be sent to you by our sales person, please always keep it as confidential.
- ※ Product database can be created from both mobile and computer systems. However, we suggest do it from mobile system, as it is more convenient.
- ※ The products you created can be used for ALL machines under this user name. No need to create products for each machine.

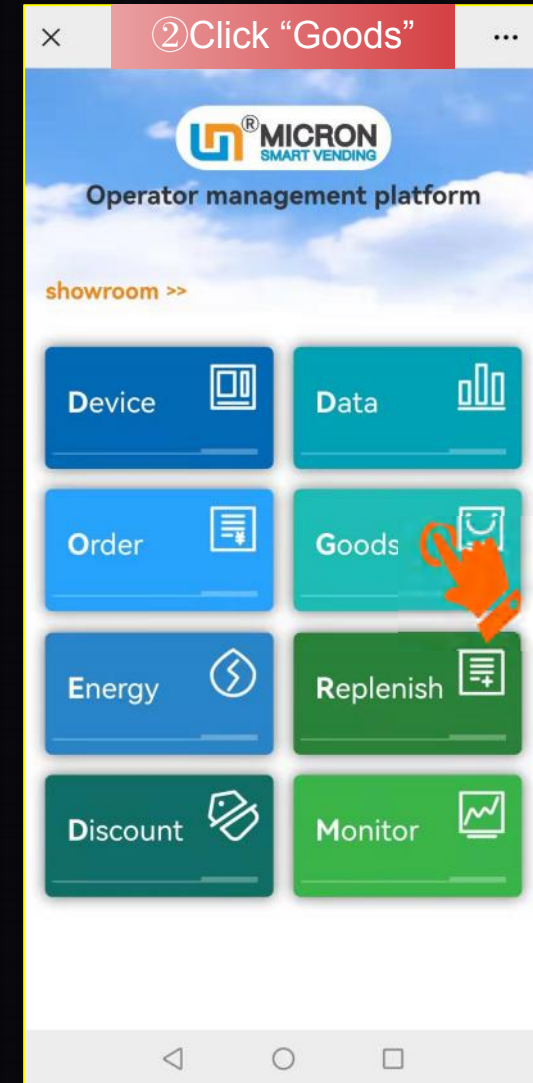
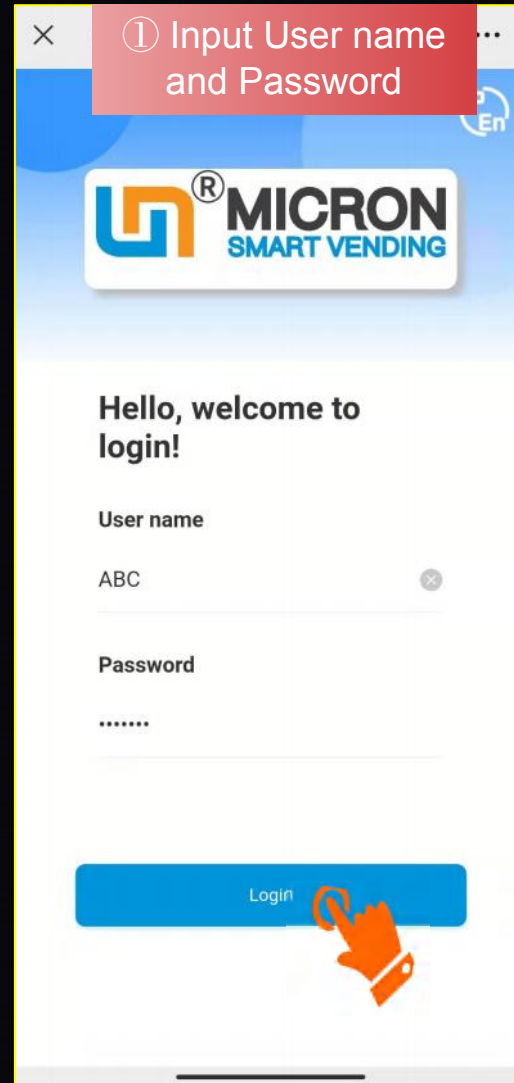

Part II: Fast setup - Step 2



2.2 Create product data base

① Click “+” to add new products

GoodsName Commodity t...

No.	Commodity	Price	operation	
1	Pessi 164577513...	1.35		
2	JXB-Lemon 164577528...	1.55		
3	Herb Jelly 164577545...	0.75		
4	JDB-Herbal... 164577534...	1.65		
5	KSF-Mango 164577519...	0.85		
6	Coca-Cola 164577505...	1.5		
7	Test 164491334...	0.1		

② Fill in the product info., and Submit

Goods info

Picture

*Code 16445489191963470

*Name

Buying price

*Sale price

type

Specification **Piece/Bottle/Pack/Can...**

*Smart fridge sell by piece, must be filled, other machines, can just fill "1"

Weight g

*Smart fridge sell by piece, must be filled, other machines, can just fill "1"

Remarks

Submit

Optional:
Create product type. For future batch operation.

运营商管理平台

Goods

No.	type	Code	operation	
1	Dessert	JF2000		
2	Salad	061804		
3	Lunch box	000111		
4	Snack	123456789...		
5	Drinks	061803		
6	Fruits	061802		
7	Vegetable	061801		
8	TestProduct02	TST002		

运营商管理平台

Goods_type

*Code:

*Name:

Remarks:

Submit

Part II: Fast setup - Step 3



2.3 Machine product set up

From Product database to each goods tray / slot

① Click "Device"

Operator management platform

showroom >>

Device, Data, Order, Goods, Energy, Replenish, Discount, Monitor

② Select machine

Device Code/Name, Device line

Total number: 8

- ① [Offline] 00000004, 2020-06-08 01:44:51, 601柜, Address: 东莞
- ② [Offline] 00000006, 2020-06-08 01:44:52, 微米展厅单柜机06, Address: 广州市黄埔区天泰一路1号
- ③ [Offline] 22002404, Address: [redacted]
- ④ [Offline] 81260137, Address: [redacted]
- ⑤ [Offline] 81260138, Address: [redacted]

③ Product setup

Offline, Device Code: 22002404, Model code: VM-WM22

Goods way setting: Price setup, Product setup, Stock replenish, Goods way test

Device operations: enter settings, Parameter setting, Device orders, Replenish record, Copy device, Device status, Machine restart, Operation status

④ Select tray/slot

A Cabinet, B Cabinet

1 Layer, 2 Layer, 3 Layer, 4 Layer, 5 Layer, 6 Layer

⑤ Select products

A Cabinet

1 Layer

- A1 Jack Daniels Fire, Sale by piece, ¥0.1/ Piece
- A2 熊猫, Sale by piece, ¥0.1/ Piece
- A3 Ac, Sale by piece, ¥2/ Piece
- A4 小朋友, Sale by piece, ¥0.1/ Piece
- A5 熊猫, Sale by piece, ¥0.1/ Piece

Part II: Fast setup - Step 4



2.4 Fill the machine

Till here, machine is ready for Testing!

Physical Replenishment

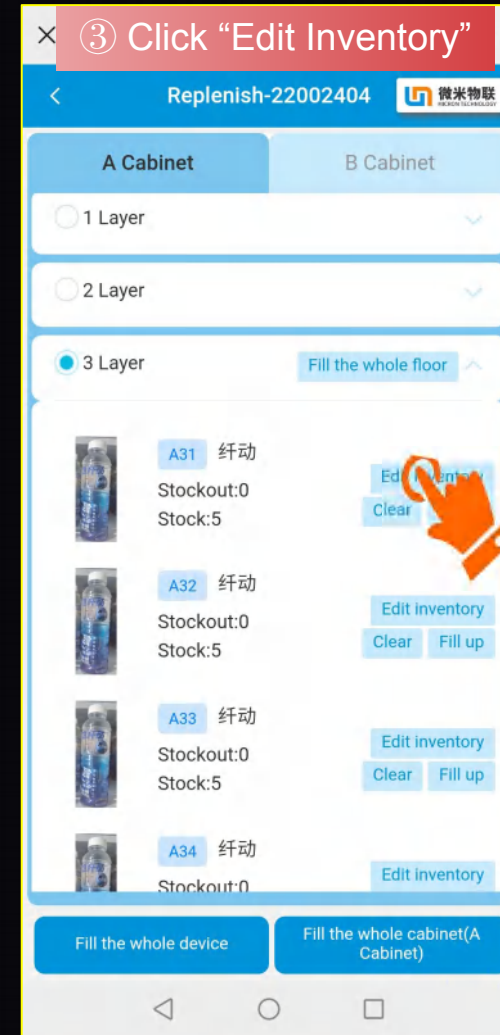
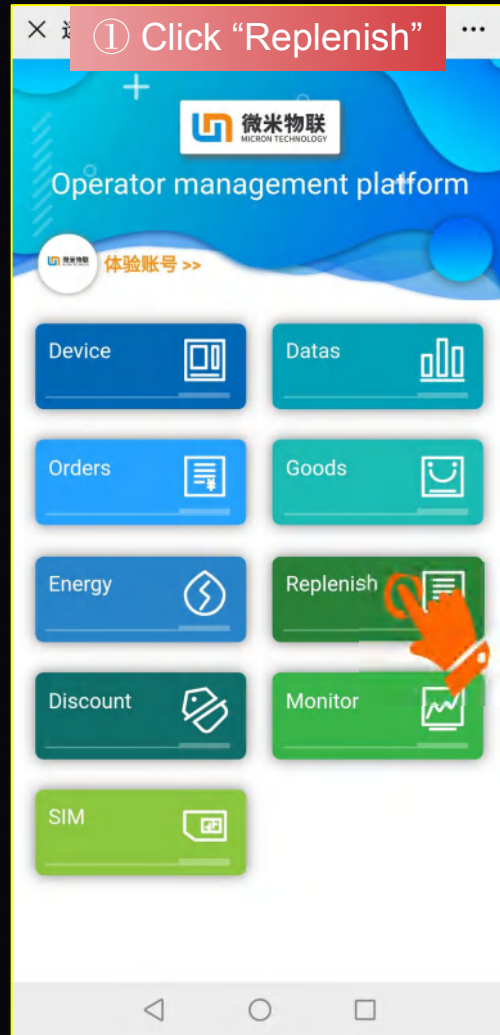

*Shortcut:
Fill the whole
floor/cabinet/
machine

Part III: Machine basic settings

3.1 How to set temperature

Temperature controller

Turn on/off cooling system



[How to set temperature?](https://www.youtube.com/watch?v=05RjsfNonu8)
<https://www.youtube.com/watch?v=05RjsfNonu8>

For vending machine with cooling system.
The temperature can be adjusted
Off set temp is 10°C (default).

Tips:
In case no Temp. controller is found there, then you can set the temperature from the Mobile phone system. (Energy module)

Part III: Machine basic settings



3.2 How to set currency symbol of selling price & set payment system

Smart phone system

Login Smart system with mobile phone

<https://moperator.tech.weimi24.com>

Click "Device" and select machine

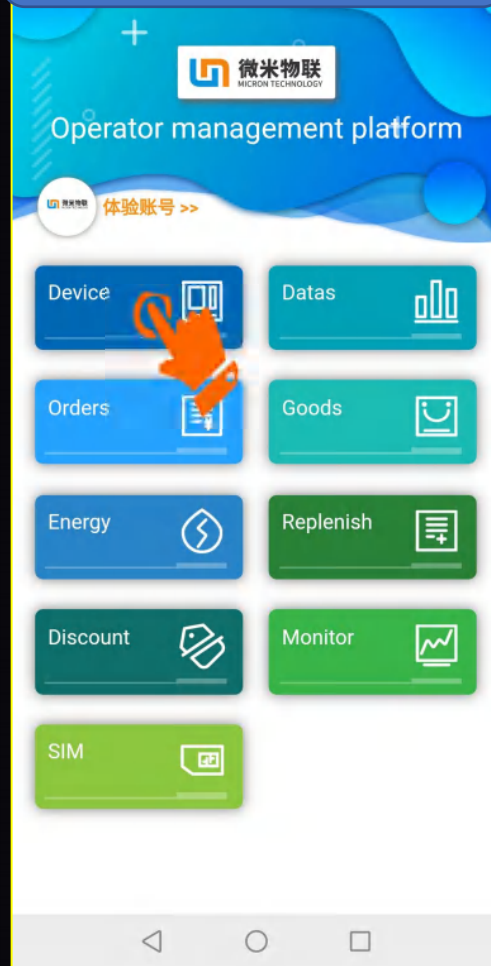

Click "Enter setting"

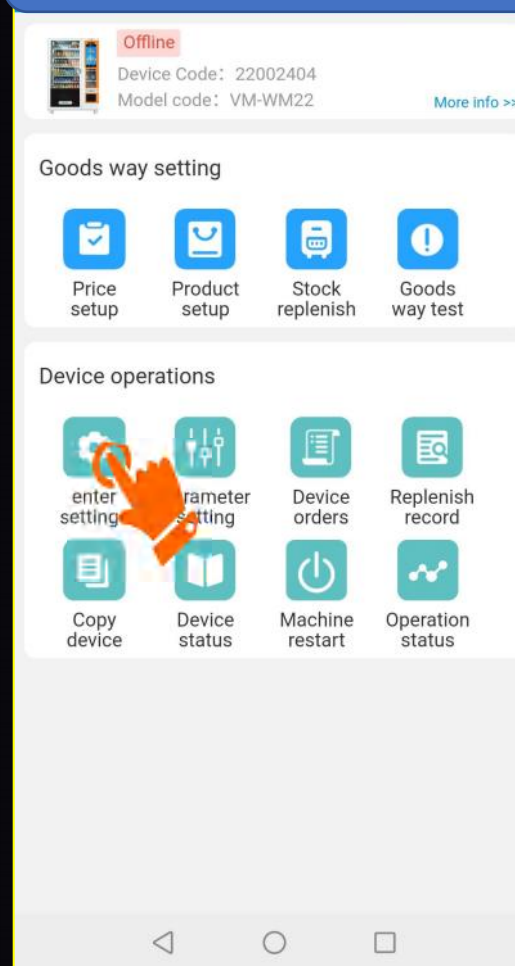

Input the password "112233550077" on the machine screen



Part III: Machine basic settings



3.2 How to set currency symbol of selling price & set payment system

The screenshot shows the machine's main interface with a top navigation bar containing 'APP setting' and 'System setting'. Below this are three buttons: 'Slot inventory', 'Motor test', and 'Slot capacity'. The 'APP setting' button is highlighted with a red circle and a mouse cursor. The main area displays a grid of slot inventory for three floors, with 'Full device replenish' buttons for each floor. A blue callout box with white text says 'Click "APP setting" on the machine screen'.

Floor	Slot	Count
Num 1 Floor	A1	1
	A2	1
	A3	1
Num 2 Floor	A21	0
	A22	1
	A23	1
	A24	1
	A25	1
	A26	1
	A27	1
	A28	1
	A29	1
	A30	1
Num 3 Floor	A31	1
	A32	1
	A33	1
	A34	1
	A35	1
	A36	1
	A37	1
	A38	1
	A39	1
	A40	1

The screenshot shows the 'APP config' settings screen. It lists various system parameters such as 'Android version', 'Hardware info', 'Product type', 'Hardware version', 'Software version', and 'Features'. The 'Features' section includes toggle switches for 'Turn on the infrared sensor', 'Show internal Ads', 'Display "Sold out"', 'Display "Buy" button', 'Use shopping cart', 'Maximum product qty for shopping cart', 'Combine slots with same product', 'Delivery mode selection', 'Enable hardware', and 'Hardware setting'. The 'Hardware setting' option is highlighted with a red circle and a mouse cursor. A blue callout box with white text says 'Click "Hardware setting" and "Enable hardware"'. The 'Enable hardware' toggle is currently turned on.

Part III: Machine basic settings



3.2.1 How to set currency symbol of selling price

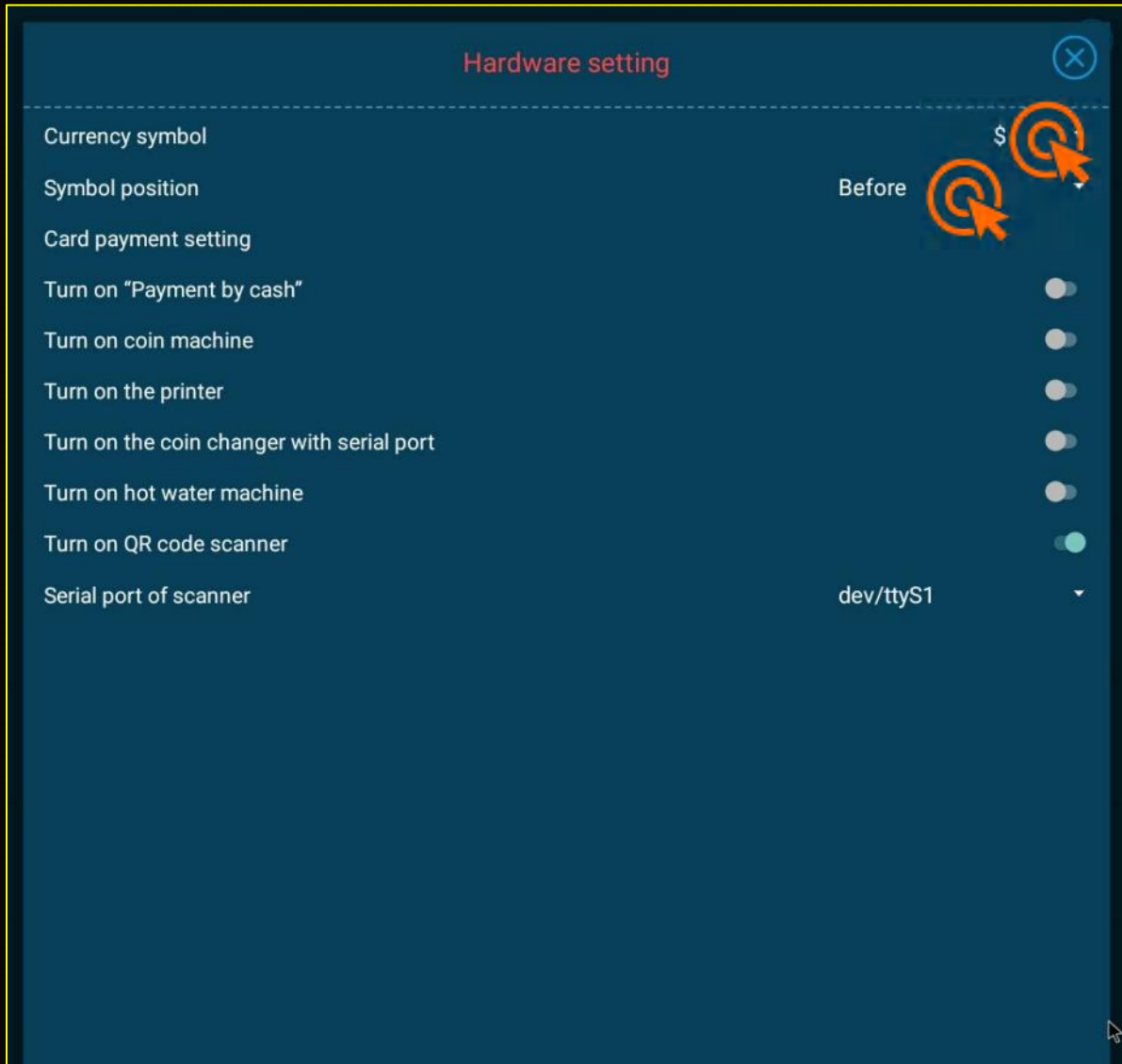

Click "**Currency symbol**"

And then

Select the symbol

Besides, you can choose the position of the symbol **before or behind** the price "\$ 1.50" or "1.50 \$"

Part III: Machine basic settings



3.2.2 How to set payment system (based on the actual payment system)

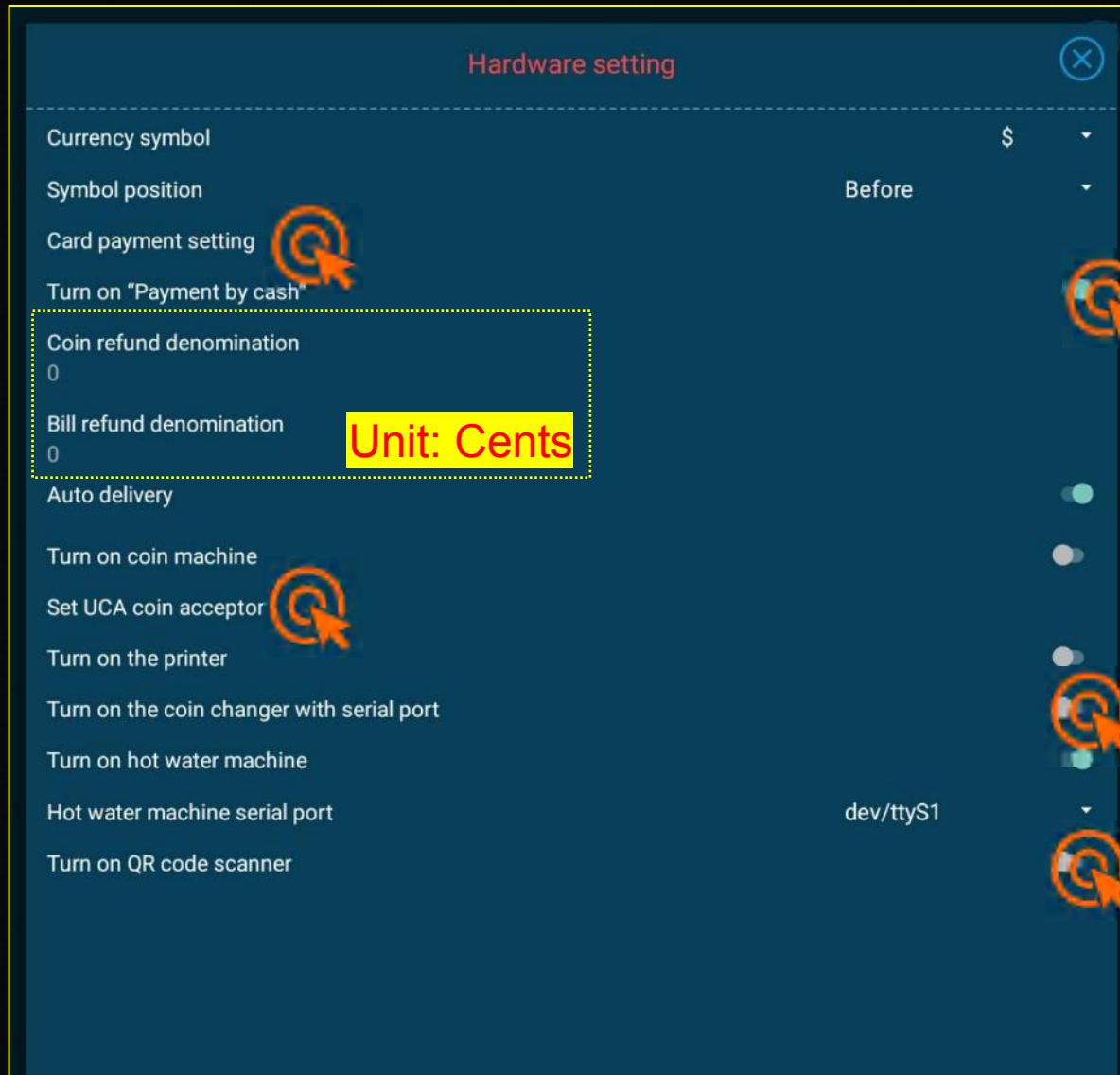

Click “**Card payment setting**” to set the card readers;

Click “**Payment by cash**” to set the bill validator and coin machine; If it can refund small changes, then set the denominations [unit: cents]

Click “**Turn on coin machine**” to set the coin acceptor which accept coin only(not refund small changes);

Click “**Turn on coin changer**” to set the coin changer which refund coin only(not accept coins);

Click “**Turn on QR code scanner**” to enable payment by e-wallets;



3.3 How to set the time of entering advertisement page (from machine)

After you uploaded advertisement, when no one use the machine for a while, it will enter into advertisement page automatically. The default time will be 60s...And you can re-set the time from the machine screen.



Buying page

60s



Playing Ads



Press any key
on the keypad

Part III: Machine basic settings



3.3 How to set the time of entering advertisement page (from machine)

Log in your mobile management system.

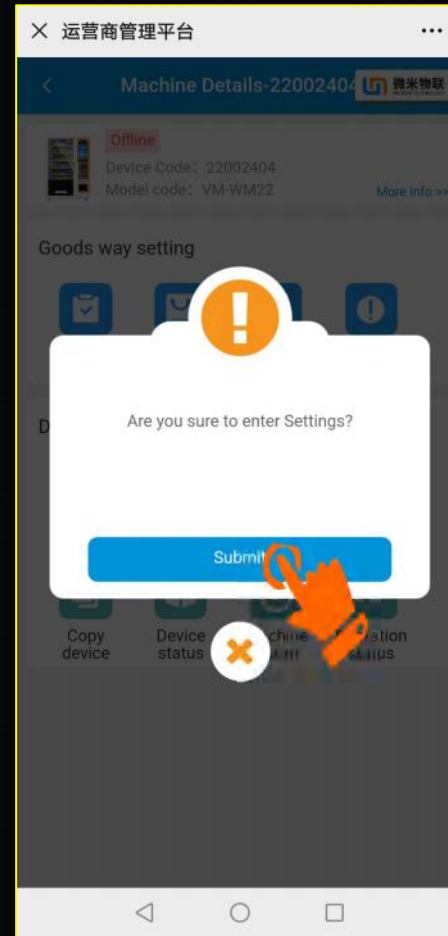
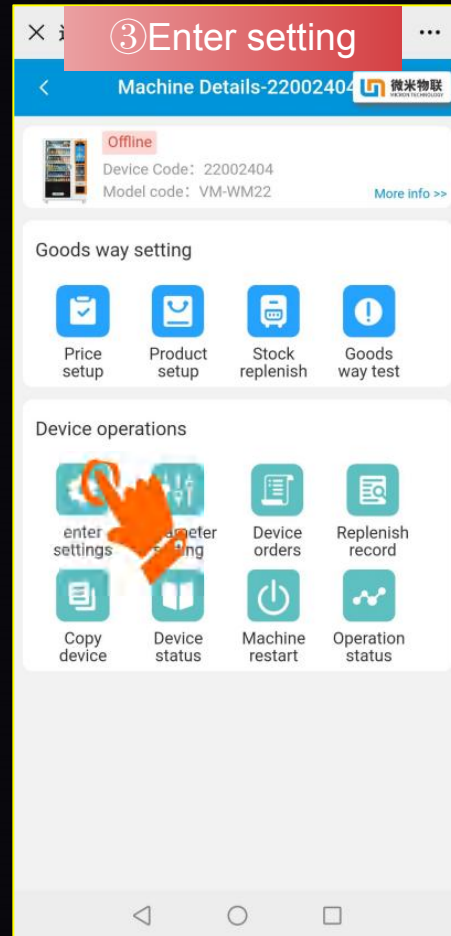
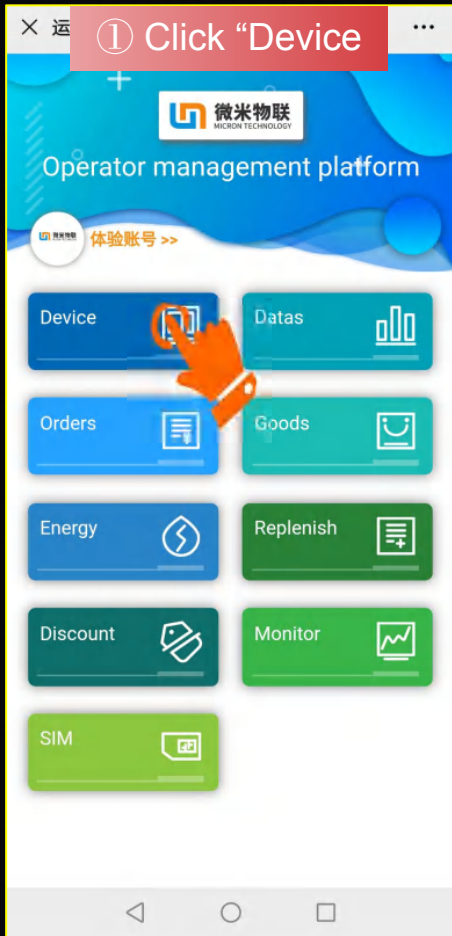

Input the password 112233550077 on the machine screen



Part III: Machine basic settings



3.3 How to set the time of entering advertisement page (from machine)

You can set the time as you like: input the number, and then click “confirm”.

Input the password
“112233550077”
on the machine screen

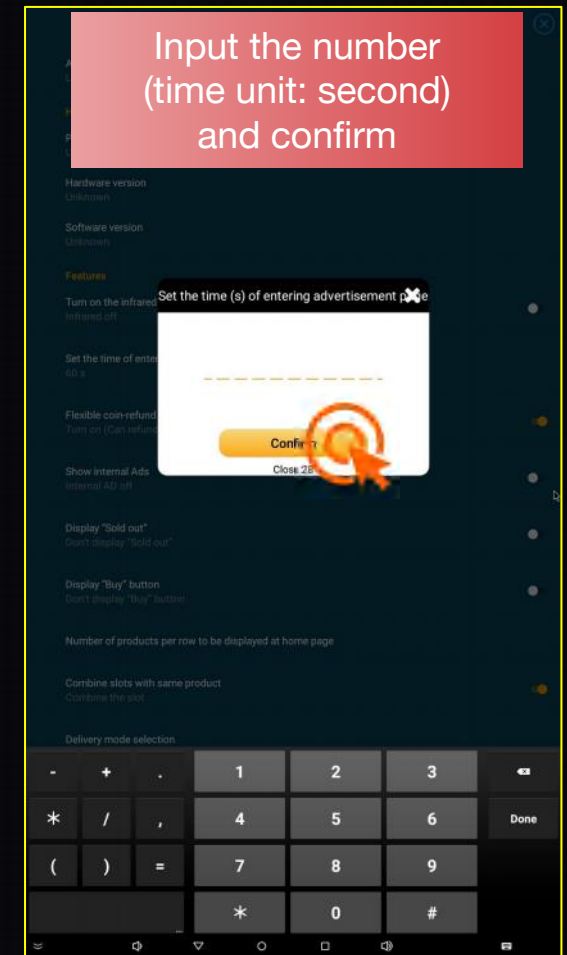
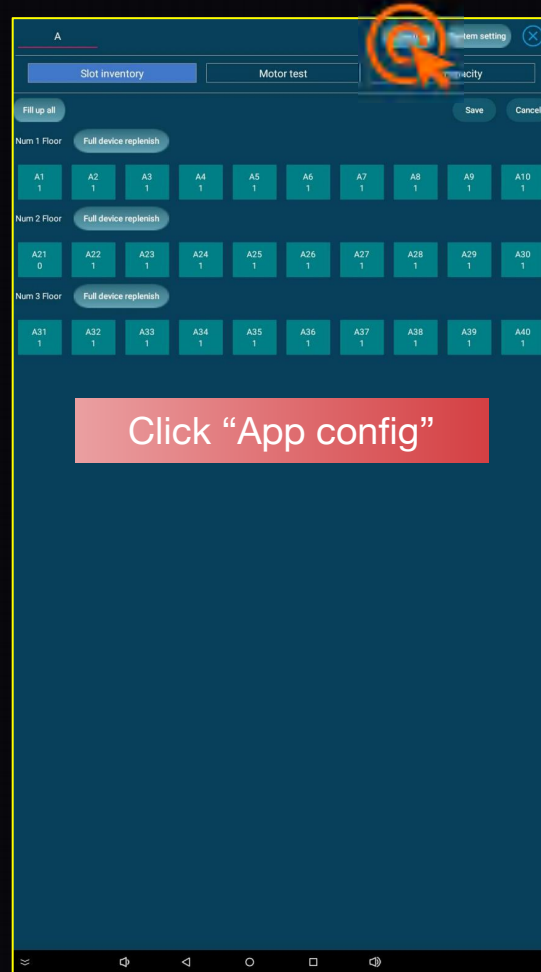

Part III: Machine basic settings



3.4 How to hide status bar (from machine)

[How to hide status bar?](https://www.youtube.com/watch?v=aNeQR_ClyHA)
https://www.youtube.com/watch?v=aNeQR_ClyHA

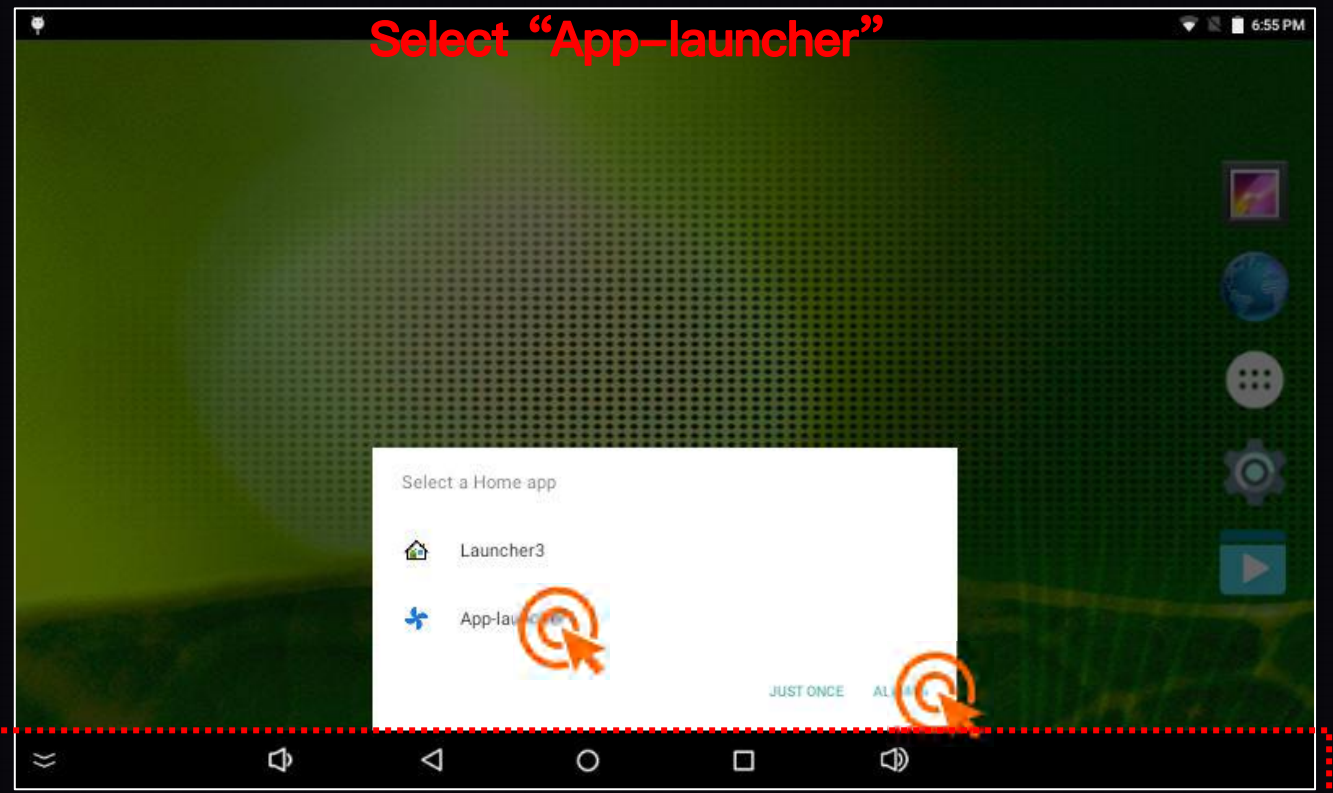
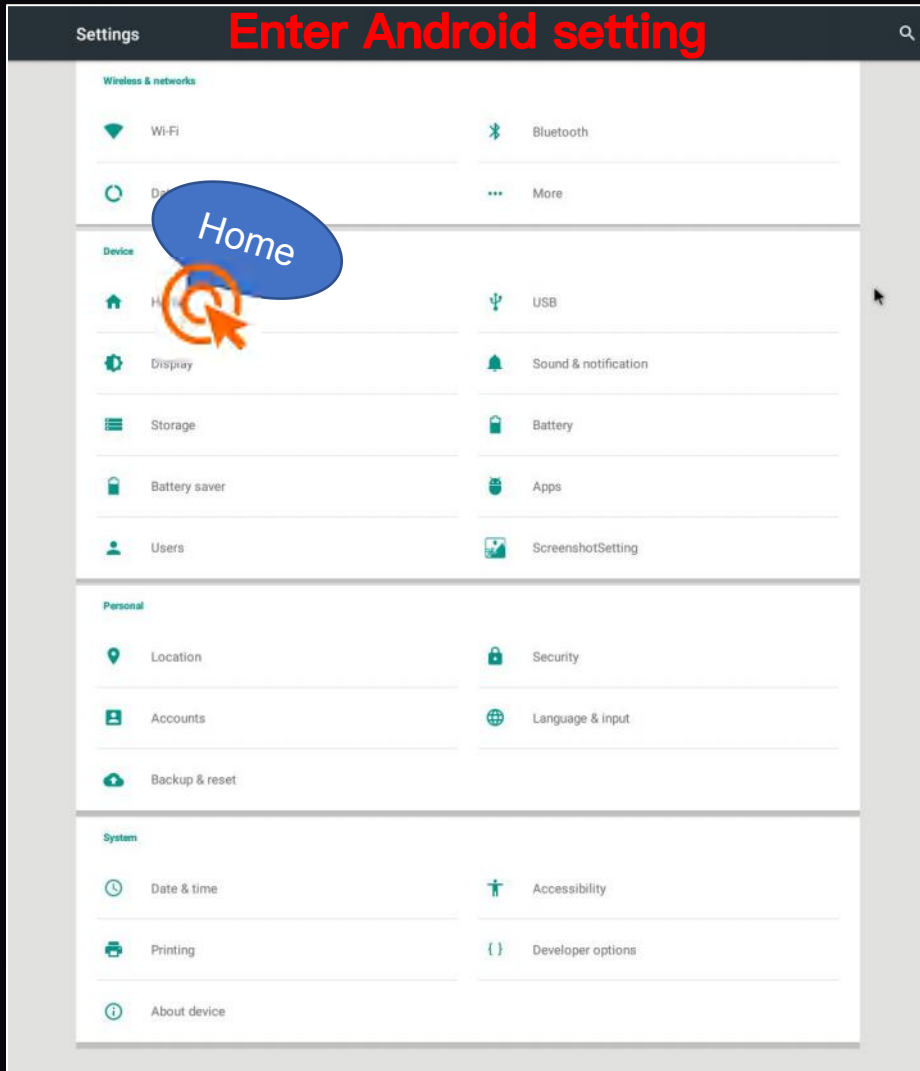

Before hide the Status Bar, please Select “App-launcher”, so that it can go back Vending App from other page in 90s automatically.

Part III: Machine basic settings



3.4 How to hide status bar (from machine)



How to hide status bar?

https://www.youtube.com/watch?v=aNeQR_ClyHA

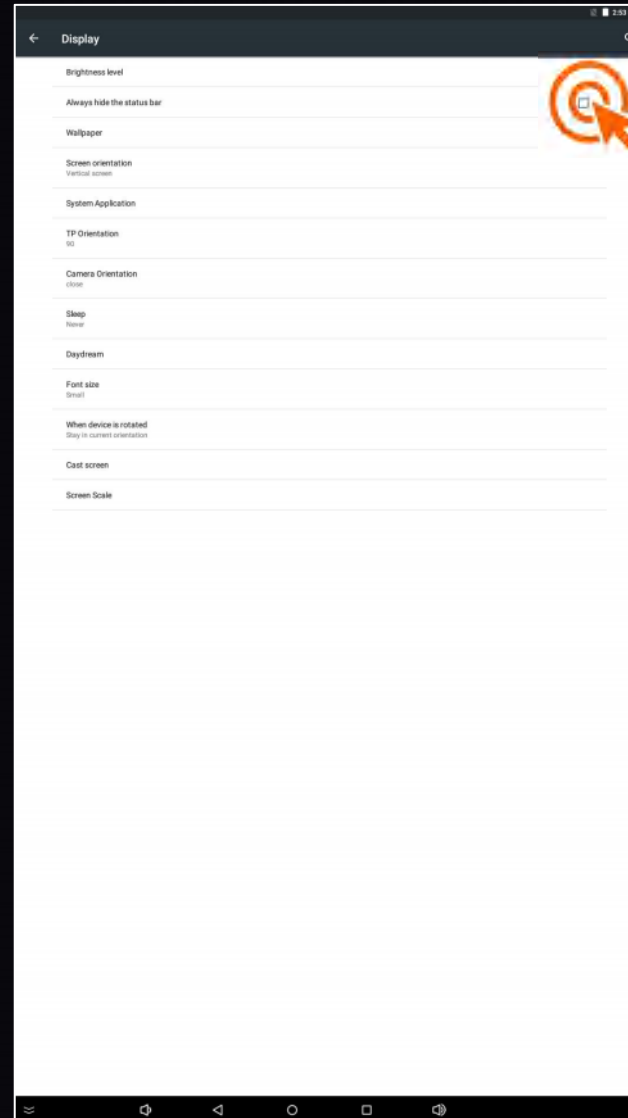
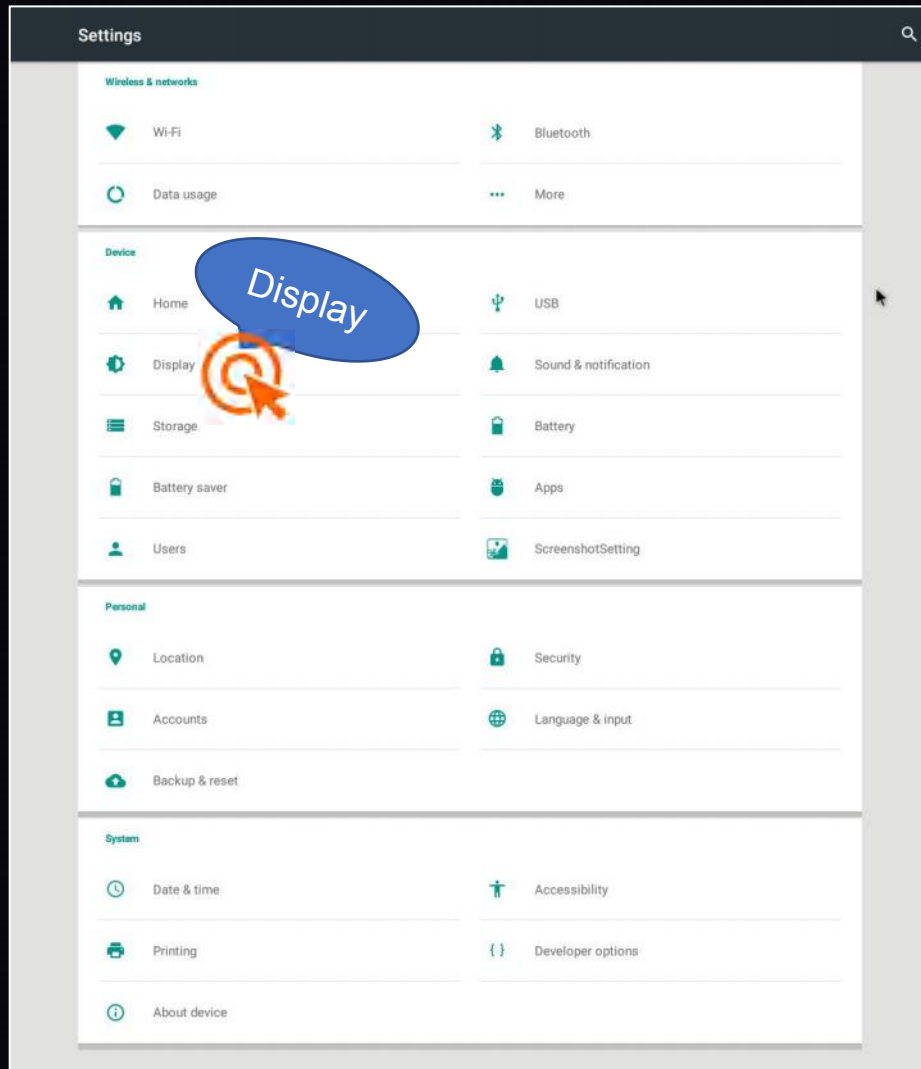

Always hide the status bar

After finished setting, please tick this box to **“always hide the status bar”** avoid confusion to the users

Part III: Machine basic settings



3.5 How to save coins to the coin machine (from machine)



[How to save coins?](#)

www.youtube.com/watch?v=q5EBCHGN5c

If your vending machines can return coins, please make sure there are enough coins inside the coin machine, to maintain the normal operation.



① Enter the password "112233550066" from the keypad, then it will switch from buying page to the coin setting mode.

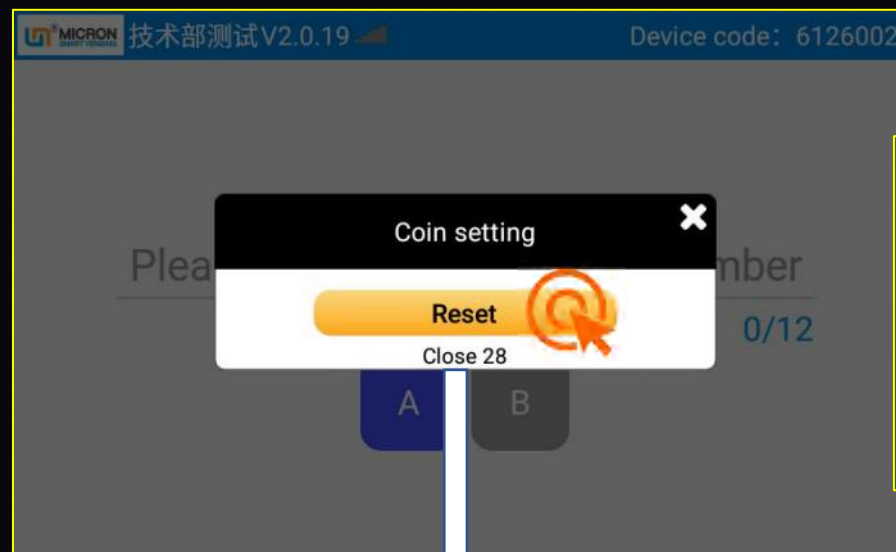

② If the machine has an integrated coin machine (acceptor&changer), you will see this page. Put the coins into the coin machine 1 by 1, and then enter this page as per step ①, click "Reset".

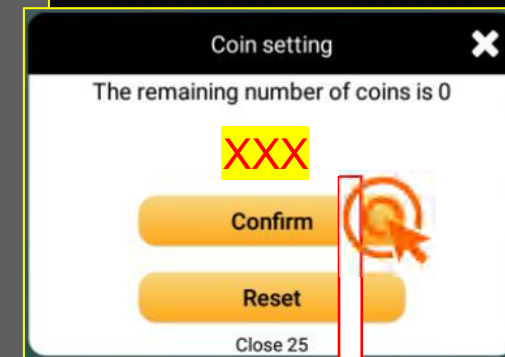

② If the machine has coin changer only, you shall put the coins into the coin changer, and then enter this page as per step ①, input the number (not amount) of coins, and Confirm.

Part III: Machine basic settings



3.6 How to check the Balance amount of the coins (from mobile)

Click "Device"

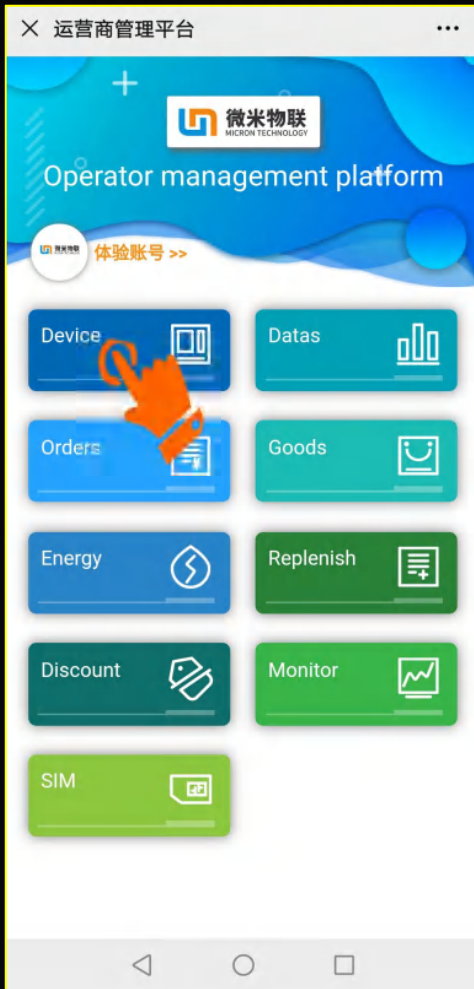

Choose the machine

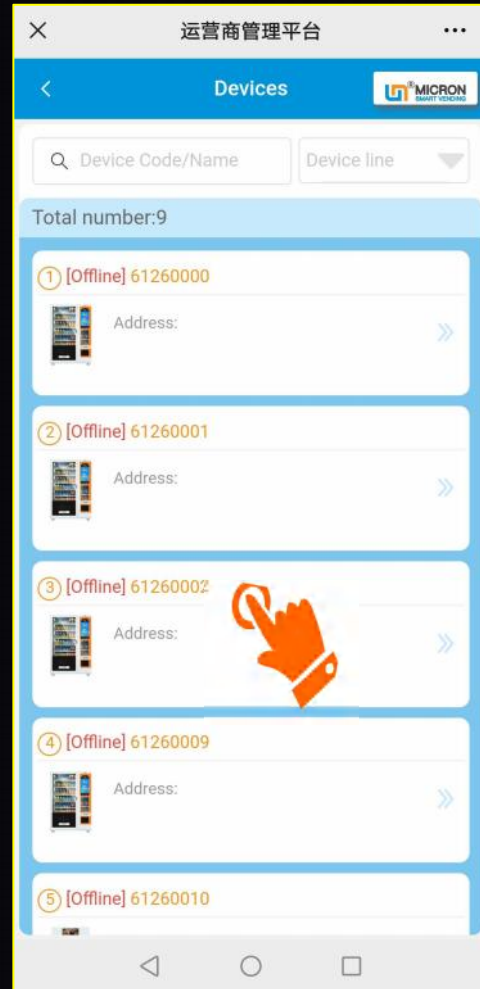

Click "Device coin"

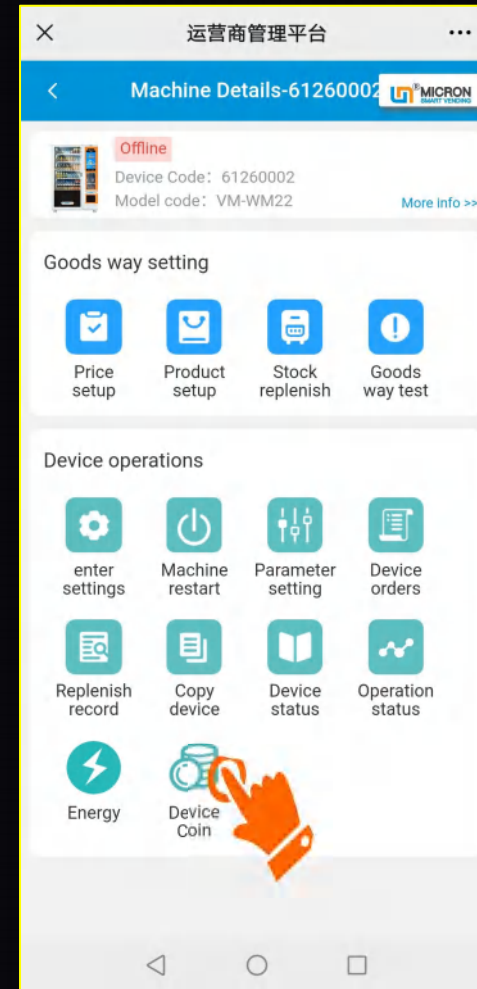

Click "Refresh"

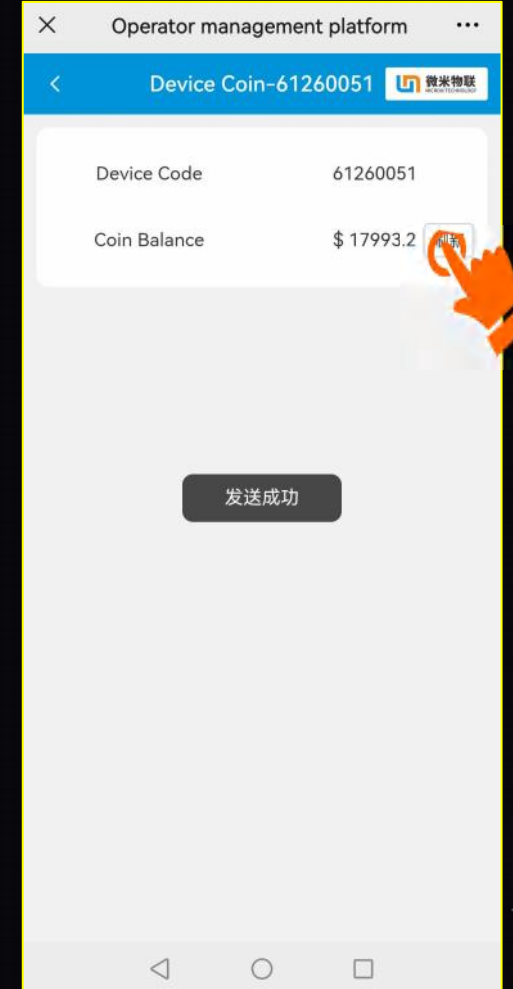

Part III: Machine basic settings



3.7 How to amend the Capacity of the goods trays

Smart phone system

Login Smart system with phone

<https://moperator.tech.weimi24.com>

Click Device

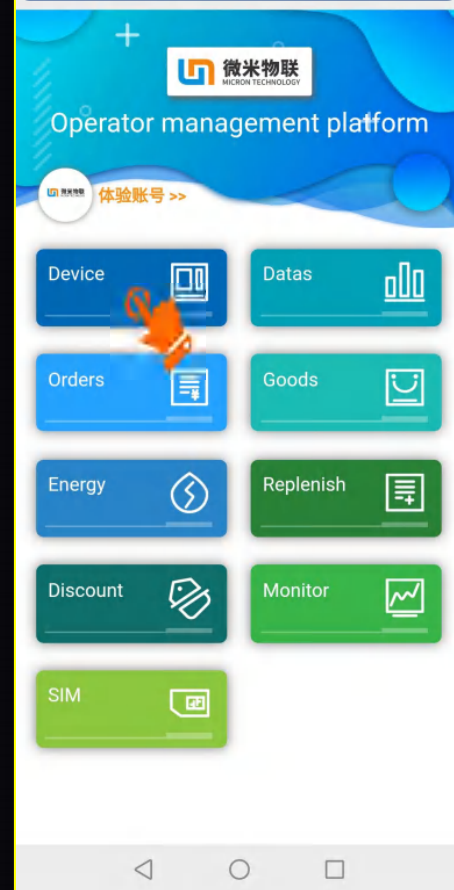

Select machine

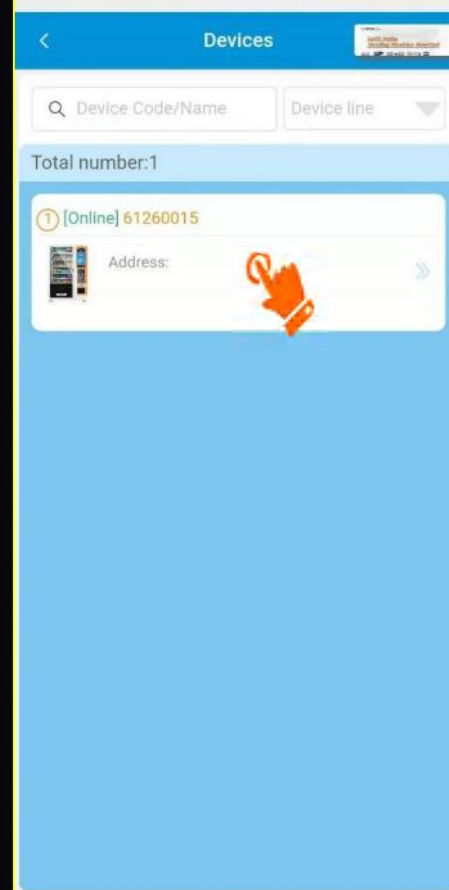

Capacity setting

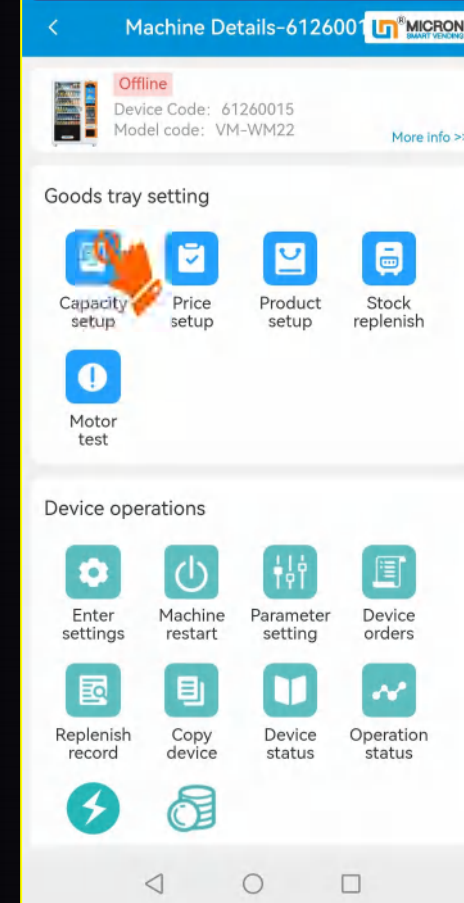

Edit capacity

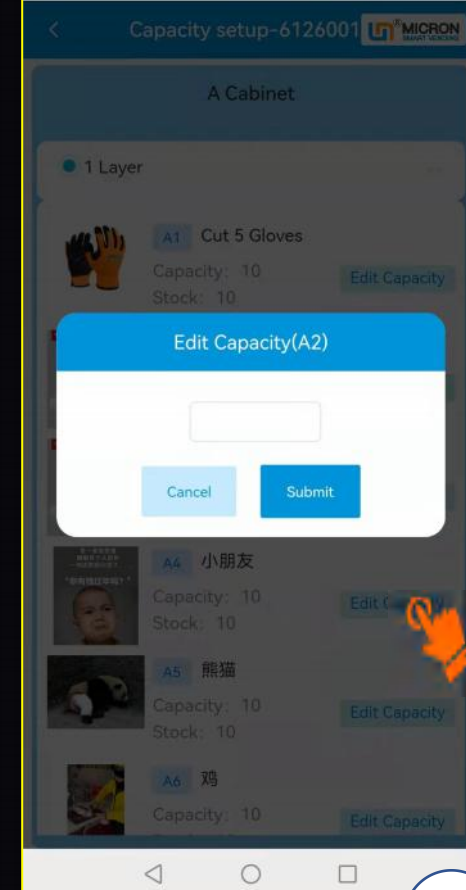

Part III: Machine basic settings



3.8 How to set product shelf life date (Expiration) & warning (from mobile)

For those items (such as food) which shall be sold before a specific date, you can set the shelf life dates for the products when you put them to the shelf, and set warnings a few days before they expired.

① Click "Device"

② Select the machine

③ Click Stock replenish

④ Click the [Shelf life] you will see "Shelf life"

⑤ Set the Shelf life date, and warning date

Part III: Machine basic settings



3.8 How to set product shelf life date (Expiration) & warning (from mobile)

After you set the dates, you will see the reminder as follow:

The sequence of screenshots illustrates the workflow:

- Screenshot 1:** The 'Machine Details-61260015' screen. The 'Stock replenish' icon is highlighted with a hand icon, indicating the user's selection.
- Screenshot 2:** The 'Replenish-61260015' screen for 'A Cabinet'. It shows a list of products: A1 Cover iPho... (Stock:10), A2 Mask (Stock:5), A3 Mask (Stock:5), A4 Herbal tea (Stock:10), and A5 Banco de c... (Stock:10). A red box highlights a warning message: 'A2 Goods have expired, please handle them! (Shelf life time 2022-04-13)'. A hand icon is shown clicking the 'Shelf life' link for product A2.
- Screenshot 3:** The 'Machine Details-61260015' screen. The 'Expired warning' icon is highlighted with a hand icon.
- Screenshot 4:** A modal dialog box titled 'Commodity maturity profile: A2(0-A1) : Expired (2022-04-13)' with a 'Confirm' button.

Part IV: Features dictionary



4.1 How to upload advertisement (PC system)

How to upload advertisements?

<https://www.youtube.com/watch?v=BNJ49G07CmY>

Login the system from your computer by User name/Password

PC Smart system

Login Smart system with Computer:

<https://operator.tech.weimi24.com>



Part IV: Features dictionary



4.1 How to upload advertisement (PC system)

How to upload advertisements?

<https://www.youtube.com/watch?v=BNJ49G07CmY>

The screenshot displays the MICRON SMART VENDING PC interface. On the left is a sidebar menu with the following items: Home, Operation_center, Goods_manage, Machine_manage, Advertising_manage, Ad_content, Ad_release, Order_manage, discount_manage, Replenishment Manage, Monitoring_center, and Data_center. The 'Advertising_manage' and 'Ad_content' items are highlighted with red boxes. The main content area shows the 'Ad_content' page with a table of existing ads and a modal dialog box for adding a new ad.

Add ad content dialog box fields:

- * Ad placement: 1 - Full screen (when no one use machine)
- * Ad SN: 1 - Full screen (when no one use machine)
- * Ad type: Video
- * Ad name: AD Testing
- * Link address: Please input
- Upload video (MP4)
- Remarks: Please input

Buttons: Cancel, OK

SN	Ad ID	Text content	Display time(s)	Operation
1	4		5	Edit Delete
2	1		5	Edit Delete
3	1		5	Edit Delete
4	1		2	Edit Delete
5		723 5ab 083 585 000	0	Edit Delete
6	1		0	Edit Delete



4.1 How to upload advertisement (PC system)

Fill Ad information
Upload advertisement to the system

Add ad content

* Ad placement: 1 - Full screen (when no one use machine)

* Ad SN: 1 - Full screen (when no one use machine)
4 - Secondary screen (when machine has 2 screens)
2 - APP internal screen (when someone use machine)

* Ad type: Video

* Ad name: AD Testing

* Link address: Please input

Upload video (MP4)

Remarks: Please input

Cancel OK

Uploaded advertisement should be:

- ✘ Video (<20M/video)
- ✘ Photo(<2M/photo)
- ✘ Words

For the machine with 5" screen,
Advertisement can be only

- ✘ Full screen (when no body buying)
- ✘ The uploaded Ads can be released to all machines under the user name.

Part IV: Features dictionary



4.1 How to upload advertisement (PC system)

Machine Ad set up

- ※ Select the Ad_contents from database which was created in above step;
- ※ Release to all the machines, or a Designated line, or a Designated machine.

The screenshot shows the MICRON SMART VENDING web interface. The sidebar menu on the left includes: Home, Operation_center, Goods_manage, Machine_manage, Advertising_manage, Ad_content, Ad_release (highlighted), Order_manage, and Replenishment Manage. The main content area displays the 'Ad_release' page with a search bar and a table of ad releases. A table with columns SN, scenario, Publish to, Ad type, Ad name, Link address, Jump to address, Text content, and Operation is visible. A modal window titled 'Ad publish' is open, showing options for Ad scenario (When idle, When buying...), Select ad, Publish to (Institutional ownership, Designated line, Designated machine), and select machine (with a dropdown list of machine IDs: 61260012, 61260014, 61260011, 61260013). Hand icons indicate the steps: clicking 'Ad Release', selecting an ad, and selecting a machine.



4.1 How to upload advertisement (PC system)



Playing Ads



Buying page

Press any key
on the keypad

Part IV: Features dictionary



4.2 How to upload LOGO/ Service Tel. to the machine/ server

Upload logo and service tel

www.youtube.com/watch?v=W6jyQSCwHqI&list=PLybk6qby1fLV4A5jbd9gYs5VI9DJXMCMy&index=8

PC Smart system

Input User name
and password

Login Smart system with Computer:

<https://operator.tech.weimi24.com>

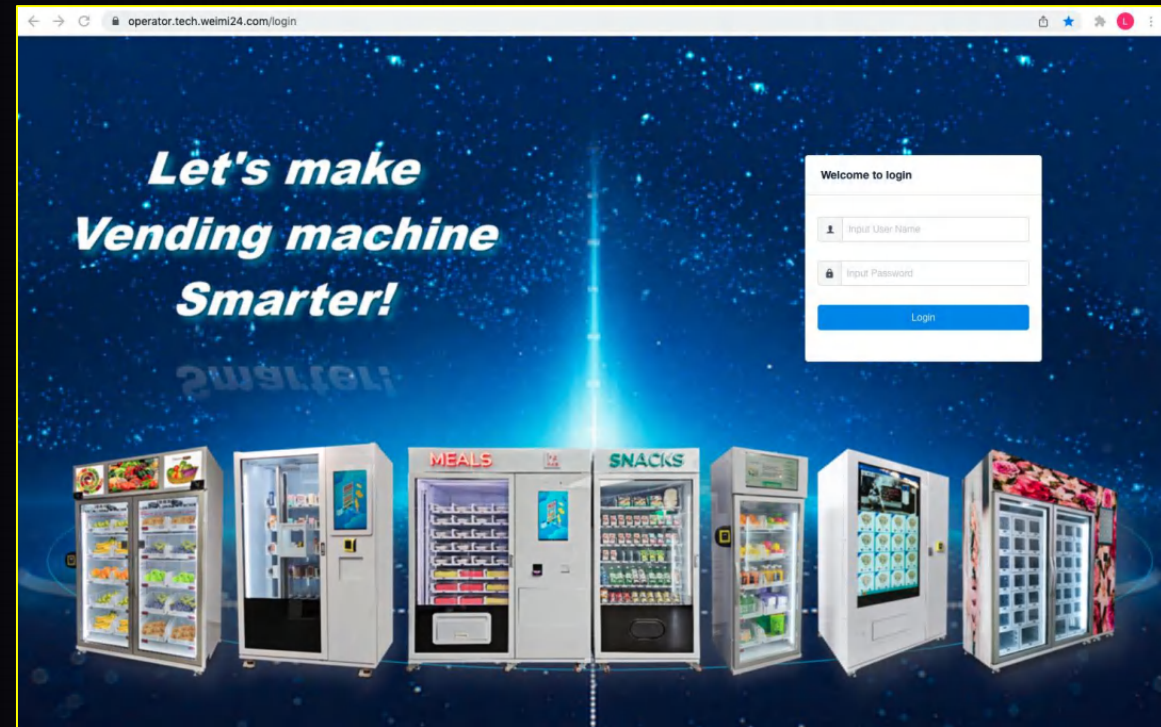

Part IV: Features dictionary



4.2 How to upload LOGO/ Service Tel. to the machine/ server

Upload logo image and input service tel

Home / system_manage / Operator_info

Welcome: showroom

Vendor name	Location	Vendor type	Business name	Business license	Bu	Operation
showroom	showroom	Personal	showroom	showroom	sh	Edit Operator settings

System language	System name	logo	Color	Hot line	Join phone	If auto refund	Operation
05ec3000	英文					No	Edit

Part IV: Features dictionary



4.2 How to upload LOGO/ Service Tel. to the machine/ server

Upload logo and service Tel. No.

www.youtube.com/watch?v=W6jyQSCwHqI&list=PLybk6qby1fLV4A5jbd9gYs5VI9DJXMCMY&index=8

You can change below logo to yours.

Logo on machine screen left top

Logo at mobile server

Logo at PC server

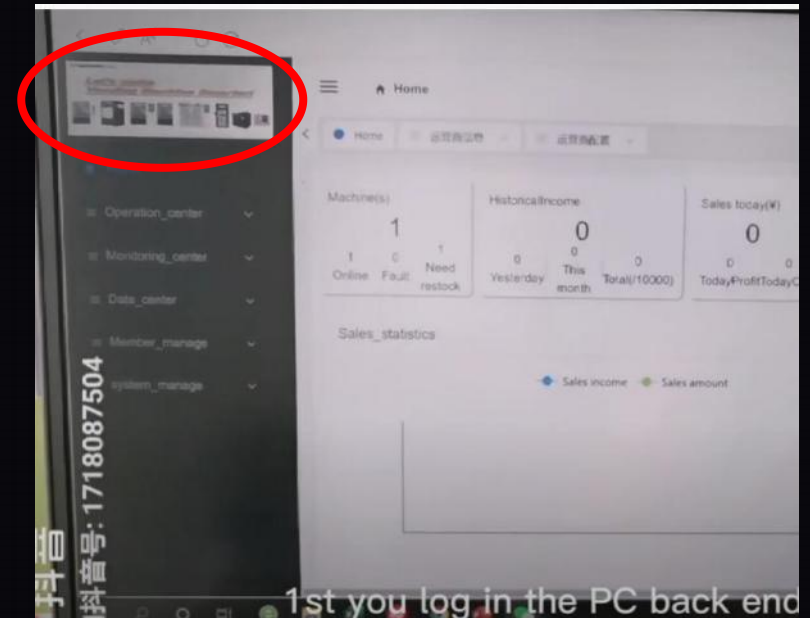
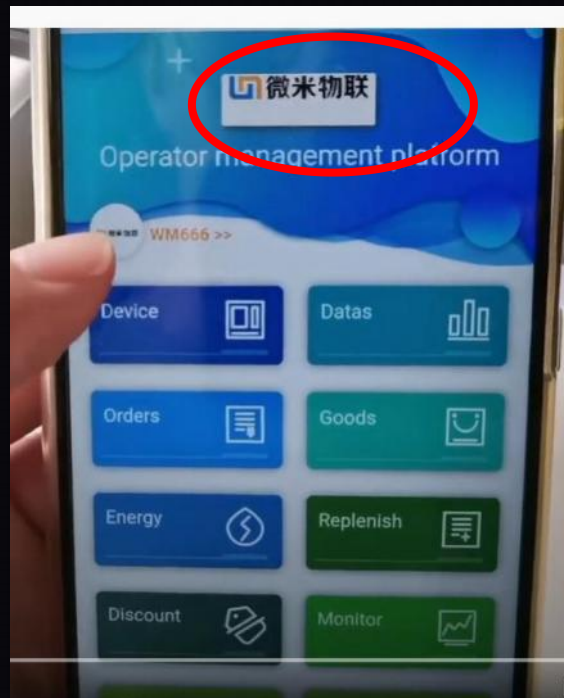

1st you log in the PC back end



4.3 How to edit machine info. (PC system)

After you deployed the machine to a location for operation, you can edit the machine info., add the Machine name, Deployment location...

In this case, you can easily manage all the machines (especially when you have many machines), to avoid any confusion by just checking the device numbers.

Login the system from your computer by User name/Password



Part IV: Features dictionary



4.3 How to edit machine info. (PC system)

※ PC System

Operation center --->

Machine manage --->

Machine list

You will see all the machines under your account.

Choose the machine that you need to edit from the list by its Machine ID.

Home / Operation_center / Machine_manage / Machine_list

Welcome: 技术部测试

Model number: Model name: Machine ID:

Machine name: Line: Agent:

Batch export inventory

SN	Machine ID	Model name	Machine name	Line	Operating
1	61260000	履带升降机			<input type="button" value="Export inventory"/>
2	61260001	履带升降机		City A	<input type="button" value="Export inventory"/>
3	61260009	标准WM22		City A	<input type="button" value="Export inventory"/>
4	61260009	标准WM22			<input type="button" value="Export inventory"/>
5	61260010	标准格子柜			<input type="button" value="Export inventory"/>
6	61260026	wm0+5寸屏			<input type="button" value="Export inventory"/>
7	61260033	升降机			<input type="button" value="Export inventory"/>
8	61260034	升降机			<input type="button" value="Export inventory"/>

Part IV: Features dictionary



4.3 How to edit machine info. (PC system)

✂ PC System

Choose the machine that you need to edit from the list by its Machine ID.

Click “Edit”, and fill in the Machine name, and Deployment location.

The screenshot displays the Micron Smart Vending PC system interface. On the left is a dark sidebar with a menu containing items like Home, Operation_center, Goods_manage, Machine_manage, Line_list, Machine_list, Advertising_manage, Order_manage, discount_manage, Replenishment Manage, Monitoring_center, Data_center, Member_manage, and system_manage. The main content area shows the 'Machine_manage' page for a specific machine (ID: 61260002). An 'Edit' dialog box is open in the center, with red boxes highlighting the 'Machine name' field (containing 'Micron') and the 'Deployment location' field (containing 'Guangzhou'). The dialog also has 'Cancel' and 'OK' buttons at the bottom. In the background, the machine details are visible, including 'Off-line' status, 'Line: 001', 'Starting time: 2020-12-15 16:55:3', 'Goods way switch', 'Device information' (Machine ID: 61260002, Card merchants: 111), 'Machine status' (Online status: Off-line, Door lock status: Close, Temperature:), and 'Operation status' (Operation status: In operating, Temporarily Closed). A red arrow points to the 'Edit' button in the top right corner of the machine details panel.



4.4 How to set sub account for your team members (PC system)

For example: if you are an **Operator**, you have 20 machines, you want to create sub-accounts for 2 re-fillers, each of them manages 10 machines:

✂ 1. Create lines

- ① Line A, bind 10 machines;
- ② Line B, bind 10 machines;

✂ 2. Create Role

Role name: Re-filler;

Role description:

Role Permission: select from the list.

✂ 3. Add new user



How to create sub-accounts?

<https://www.youtube.com/watch?v=i8CJlfC1-GM>

Login the system from your computer by User name/Password





4.4 How to set sub account for your team members (PC system)

※ 1. Create lines

Operation center --->
Machine manage --->
Line list ---> Add new line
---> Binding machine

① Line A, bind 10 machines;
② Line B, bind 10 machines;
e.g. you can name the Lines with territories, such as City name/ District...and then bind the machines according to the machine deployed location.

The screenshot displays the software interface for creating a new line. On the left, a sidebar menu shows the navigation path: Home > Operation_center > Machine_manage > Line_list. The main area features a search bar with fields for Code, Name, and Agent, and buttons for Search and Reset. Below the search bar is a table with columns: SN, Code, Name, Remarks, Has deleted, and Operation. A table row shows SN 1, Code 002, Name City-B, Remarks, Has deleted Normal, and Operation Binding machine. A modal window titled 'Add new' is open, showing input fields for Code, Name, Remarks, and a radio button for Data state (Normal). The 'Add new line' button in the table is highlighted with a red box and an arrow pointing to the modal window.



4.4 How to set sub account for your team members (PC system)

❌ 2. Create Role

System manage ---->

Role manage ---->

Add Role

Role name: Re-filler;

Role description:

Role Permission: tick the boxes, to allow the Role to see the relevant modules when they log in their accounts.

The screenshot shows the 'Add Role' dialog box in a web application. The dialog has a title bar with a close button. It contains two input fields: '* Role Name:' and 'Role Description:'. Below these is a section for '* Role Permission:' with a list of items, each with a checkbox and a right-pointing arrow. The items are: PC-Monitoring center (checked), PC-Operation center (checked), PC-System management (checked), Mobile-Personal center (unchecked), Mobile-Device management (checked), Mobile-Replenishment management (checked), and Mobile-Discout management (checked). At the bottom right of the dialog are 'Cancel' and 'OK' buttons. In the background, a table with columns 'SN', 'Role', 'Update Date', and 'Operation' is visible. The 'Add Role' button in the top right of the background is highlighted with a red box and an arrow.

Tick the Permissions for PC system, and Mobile system respectively...



4.4 How to set sub account for your team members (PC system)

✂ 3. Add new user

System manage ---->

User list ---->

Add new user ---->

Bind Line

Select the Role of the user...And then “Bind Line” for each user.

Now, the new users can login the system, and manage those machines under each account.

The screenshot displays the 'Add new user' dialog box in the system interface. The dialog box contains the following fields and options:

- User name: Please Input...
- Password: Please Input... (with an eye icon for visibility)
- Nick name: Please Input...
- Real name: Please Input...
- Whether enabled: Yes No
- Log in with binded ID: Yes No
- Binding the ID of wechat: Please Input...
- Role: Select (dropdown menu with options: operator super a, Financial, Re-filler)

The 'Re-filler' role is highlighted with a red box. In the background, the 'Add new user' button is also highlighted with a red box. To the right, the 'Bind Line' button is highlighted with a red box, and the 'Delete' button is also highlighted with a red box.

You can create sub-accounts for your employees, such as Financial team/ purchasing team, etc...



4.5 How to set sub account for your customers (PC system)

For example: If you are a **vending machine re-seller**, you import machines from our company, all the machines are under your account.

When you sell out the machine(s) to each customer, you need to create sub account, and allocate machine(s) from your account to that customer (Agent), so that they can login and manage their own machine(s).

Login the system from your computer by User name/Password



Part IV: Features dictionary



4.5 How to set sub account for your customers (PC system)

3 Steps as follow:

Agent ---->

Agent management

✘ 1. Add agent

Under your account, you can create sub accounts for all your customers.

✘ 2. Device binding

Bind the machine(s) by device number(s).

✘ 3. Configure

Do some basic settings...

The screenshot displays the MICRON SMART VENDING web interface. On the left, a sidebar menu has 'Agent' and 'Agent management' highlighted with red boxes. The main content area shows a form for adding an agent with fields for administrator account, region, name, bank name, bank account, contacts, phone, email, business license, merchant name, organization type, and remarks. A modal window titled 'Add agent' is open, showing these fields. A red arrow points from the 'Add agent' button in the background table to the modal. A green arrow points from the 'Device binding' button in the background table to a 'Device binding' modal window. The 'Device binding' modal shows a list of device numbers with checkboxes, where '61260010-' is selected. A blue thought bubble contains the text 'Default login password is 123456'. A yellow box highlights the 'Agent management' menu item.

Part IV: Features dictionary



4.5 How to set sub account for your customers (PC system)

✂ Account setting

After the sub account is created, login to the system by User name and default password 123456.

System_manage ---->

Operator_info ---->

Operator settings ---->Edit

The account owner can upload Logo, input the Service Tel. No., change passwords, etc...

The screenshot shows the Micron Smart Vending PC system interface. On the left is a dark sidebar with the logo '微米物联' and a menu. The main content area is titled 'Operator_info' and contains two tables. The top table lists vendor information, and the bottom table lists system configuration details. Red boxes and arrows highlight the 'Operator settings' button in the top table and the 'Edit' button in the bottom table.

Vendor name	Location	Vendor type	Business name	Business license	Operation
Micron	GD	Legal person	GZ Micron		Edit Operator settings

Vendor ID	System language	System name	logo	Color	Hot line	Join phone	Operation
89261c7dd2c3000							Edit



4.5 How to set sub account for your customers (PC system)

※ In case you need to Sync product data base

After the sub account is created, login to the system by User name and password.

Operation center --->

Goods manage --->

Product data base

You can synchronize the product data base from a higher level operator to this new-created sub account.

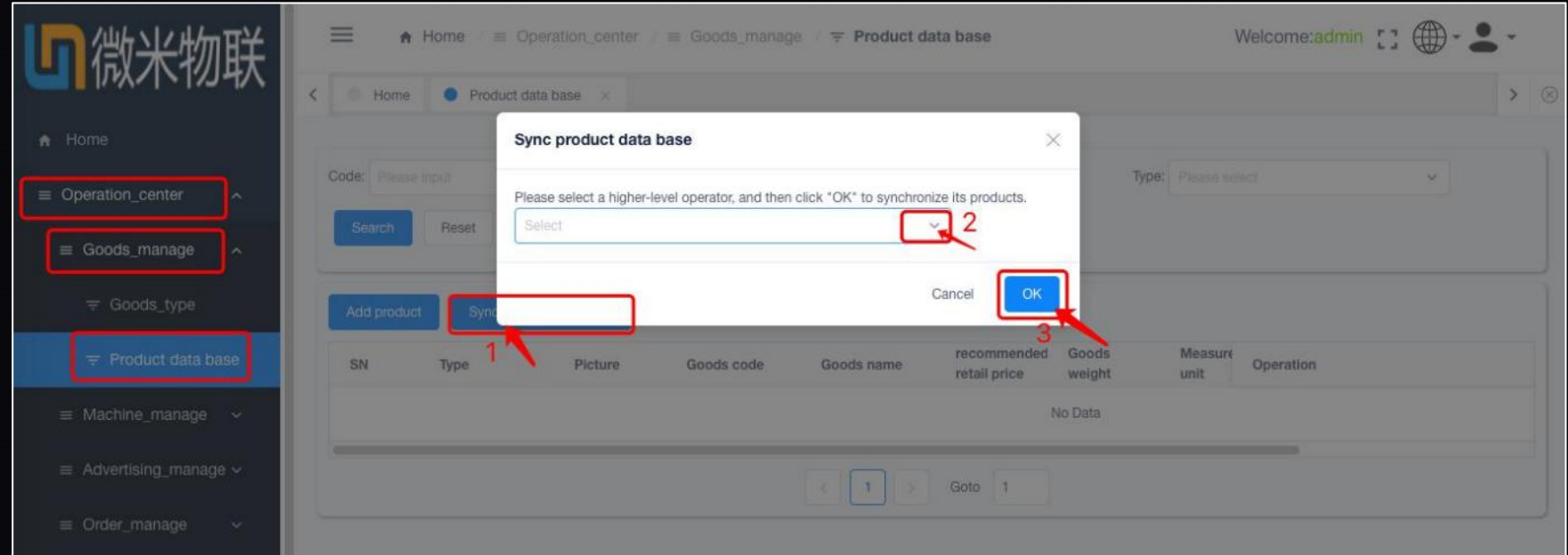

Remark:

- ① Sub account can synchronize the product data base from a high-level operator only. It is not applicable in reverse.
- ② After the product data base is synchronized, you can edit the info. freely, and add new products. If you synchronize it again, it will cover those products originated from last sync...However, it will not cover the new-added products.



4.6 How to use Member manage (PC system)

*If your machine is go with a card reader for membership cards (IC or ID card), please check this step.

※ You need to list out all the IC card number (which is written on each card body), and the Reading Code of each card (which can be read by a card reader, or you can ask your card supplier to send it to you);

① PC System ---> System manage ---> IC manage ---> Import Excel

The screenshot shows the MICRON system interface. The breadcrumb navigation is Home / system_manage / IC_manage. The page title is 'IC_manage'. There is a search bar for 'IC卡号' (IC Card Number) with '搜索' (Search) and '重置' (Reset) buttons. A blue 'Import Excel' button is highlighted with a red mouse cursor. Below the search bar is a table with columns: SN, Card number, Card reading code, Batch information, Supplier, Whether enabled, Whether binded, and Operation. The table currently shows 'No Data'. At the bottom of the table are navigation buttons: '<', '|', '>', and 'Goto 1'.

Excel format

card_number	card_code	batch	supplier
xxx	Code shall be in Hexadecimal system	1	A

Attention: the Reading code shall be Hexadecimal system

Part IV: Features dictionary



4.6 How to use Member manage (PC system)

② PC System ---> Member manage ---> Member info ---> Add new member

The screenshot displays the MICRON SMART VENDING PC system interface. On the left is a dark sidebar menu with the following items: Home, Operation_center, Monitoring_center, Data_center, Member_manage (highlighted with a red box), Member_info (highlighted with a blue box), Member_fund, and system_manage. The main content area shows the 'Member_info' page with a breadcrumb trail 'Home / Member_info'. A blue 'Add new member' button is highlighted with a red mouse cursor. A modal window titled 'Add new member' is open, containing the following fields: Member name, Member ID, Member password (with an eye icon), Nick name, Payment password required (Yes/No radio buttons), Status (normal/abnormal radio buttons), and Remarks. The modal has 'Cancel' and 'OK' buttons at the bottom. The background page shows a search bar with 'Search' and 'Reset' buttons, and a table with columns 'SN' and 'Member name' containing 'No Data'.

Part IV: Features dictionary



4.6 How to use Member manage (PC system)

③ PC System ---> Member manage ---> Member info ---> Binding IC card

The screenshot displays the 'Member info' page in the PC system. A modal dialog titled 'Binding IC card' is open, containing two required fields: '* Binding card number' (a dropdown menu) and '* Cardholder' (a text input field). The background shows a table of members with columns for SN, Member name, Mobile, and Operation. The 'Operation' column for the first member (SN 1, 张学友) has a 'Binding IC card' button highlighted with a red circle. The 'Member ID' search field is visible at the top of the page.

SN	Member name	Mobile	Operation
1	张学友		Balance adjustment, Binding IC card, IC card list, Edit, Delete
2	刘德华	162391933970	德华, Balance adjustment, Binding IC card, IC card list, Edit, Delete

Part IV: Features dictionary



4.7 How to check Real time inventory

Smart phone system

Login Smart system with phone

<https://moperator.tech.weimi24.com>

Input User name and password

微米物联
MICRON TECHNOLOGY

Hello, welcome to login!

User name
User name

Password
Please input password

Login

Click "Replenish"

微米物联
MICRON TECHNOLOGY

Operator management platform

体验账号 >>

Device Datas

Orders Goods

Energy Replenish

Discount Monitor

SIM

Part IV: Features dictionary



4.7 How to check Real time inventory

Select the machine which you want to check.

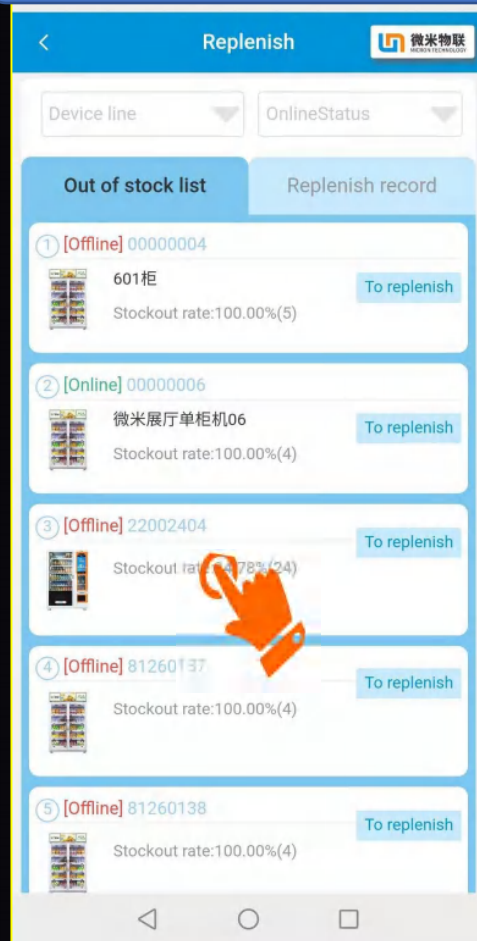

Here you can check each product inventory

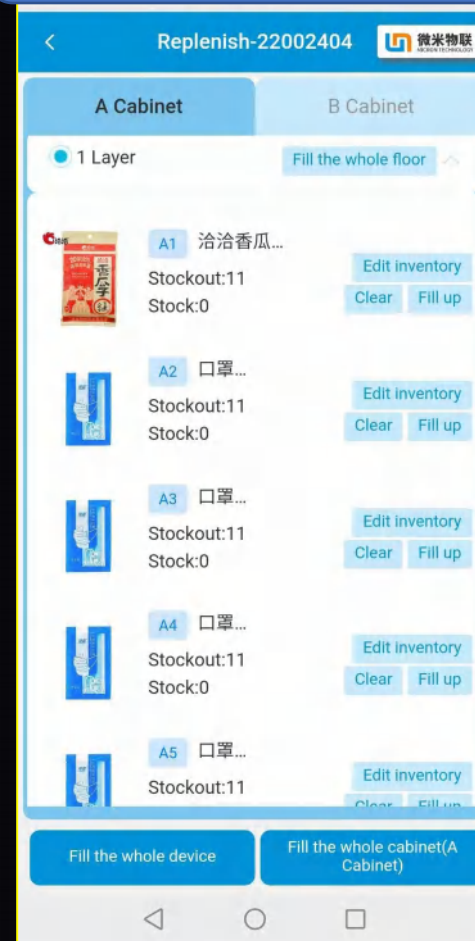

Part IV: Features dictionary



4.8.1 How to check Orders of all the machines

Smart phone system

Login Smart system with phone

<https://moperator.tech.weimi24.com>

Click Orders

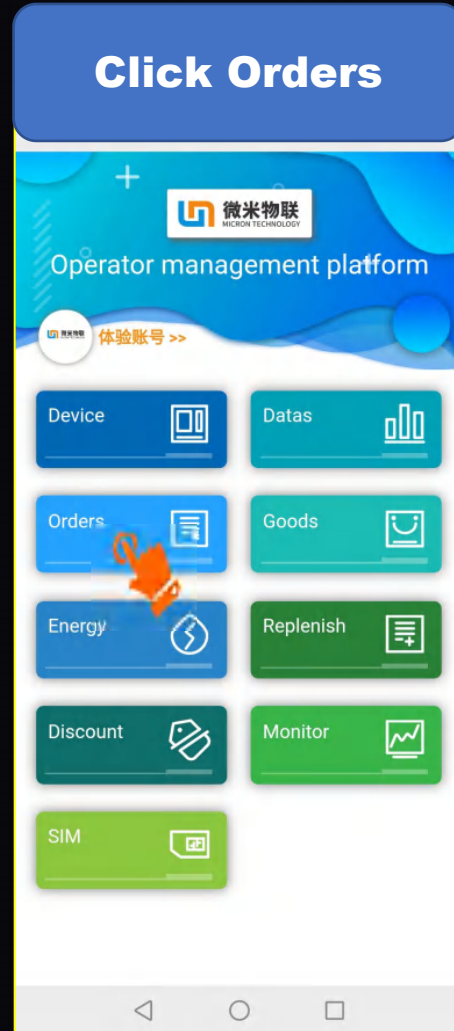

Can check today's order record

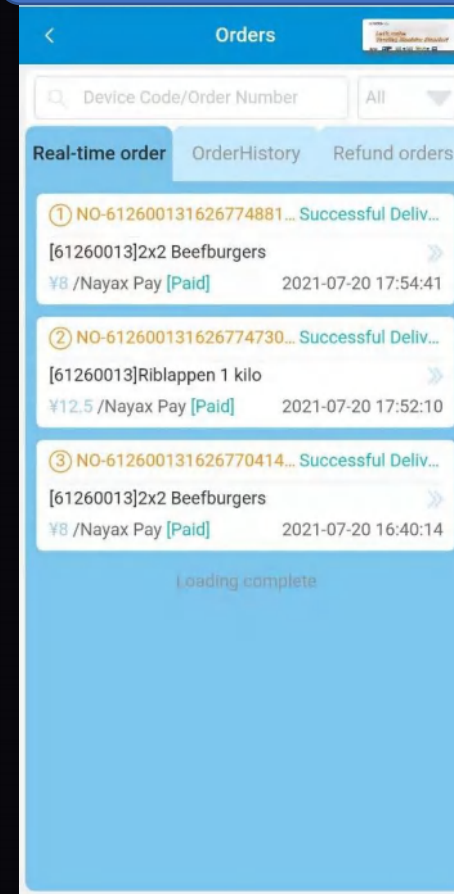

History order record

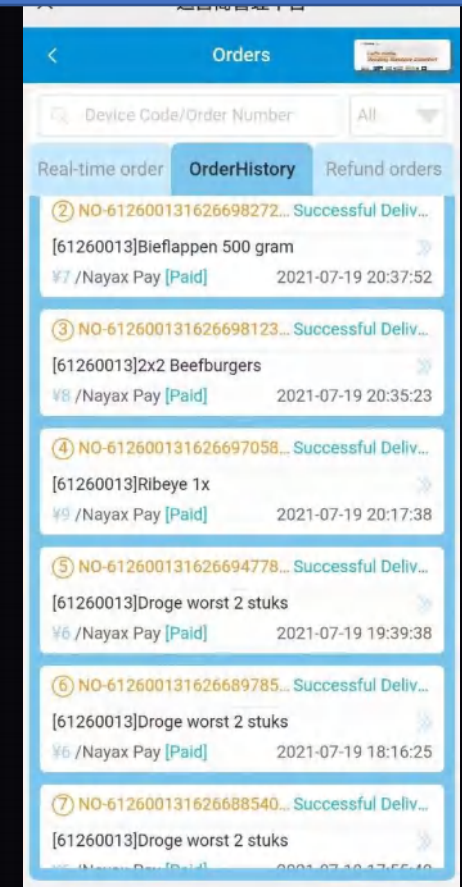

Part IV: Features dictionary



4.8.2 How to check orders of a single machine

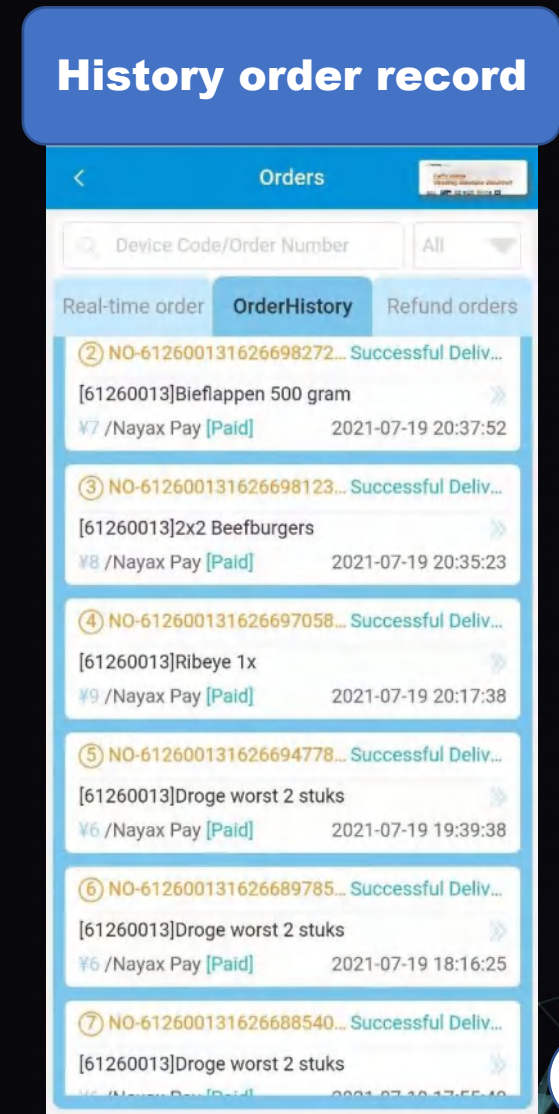
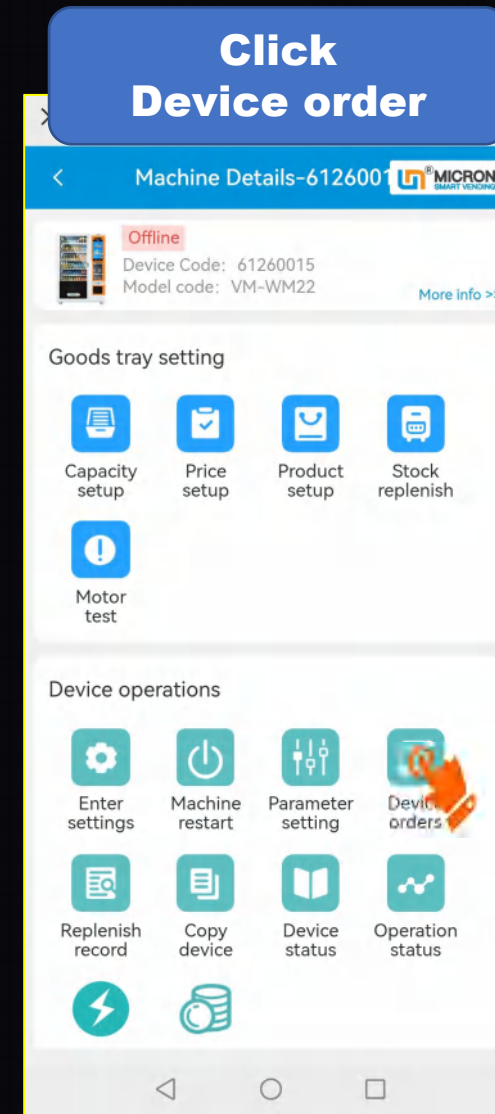
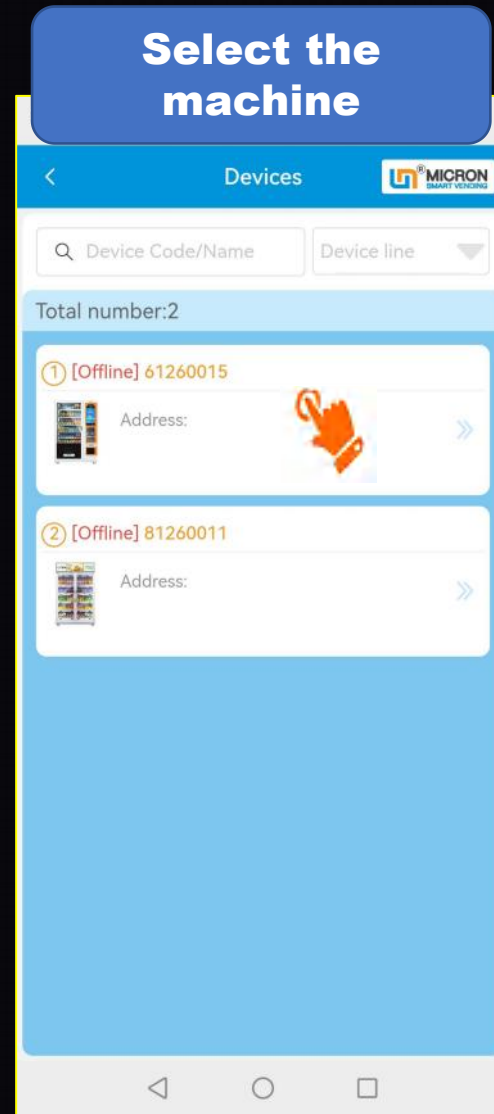

Part IV: Features dictionary



4.8.3 How to check Sales Data

Smart phone system

Login Smart system with phone

<https://moperator.tech.weimi24.com>

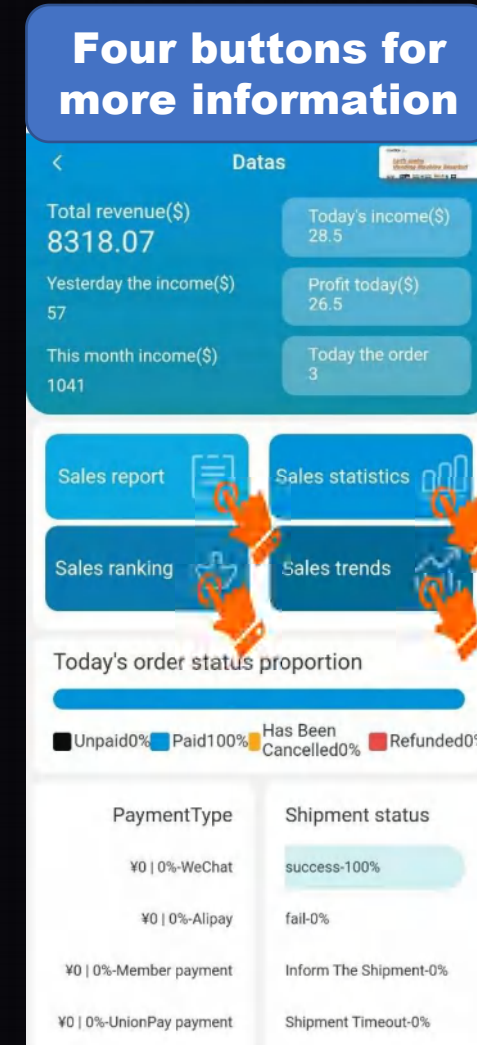
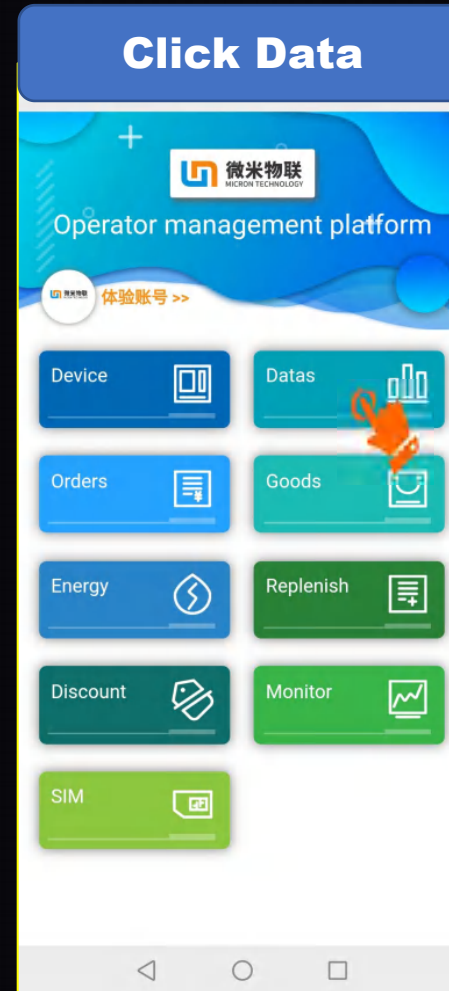



4.9.1 How to check Replenish record (PC system)

✂ 1. PC System

You can check the replenish record of ALL the machines under your account from PC system, by exporting the file in Excel format.

✂ 2. Mobile System

You can view the replenish record of ALL machines under your account, or you can just choose to view the record of a specific machine.

Login the system from your computer by User name/Password



Part IV: Features dictionary



4.9.1 How to check Replenish record (PC system)

※ 1. PC System

Operation center --->
Replenish management

You can click “Export Excel file”, and save the file to your computer, and then check all the details of all machines. Besides, you can input the Machine ID / Goods name/ Agent, and Select date to Search.

The screenshot shows the Micron Smart Vending PC system interface. The top navigation bar includes 'Home / Operation_center / Replenishment Manage' and a welcome message 'Welcome: 技术部测试'. The left sidebar contains a menu with 'Operation_center' highlighted in red. The main content area features a search form with fields for 'Machine ID: Please input', 'Goods name: Please input', 'Select date: Please select', and 'Agent: Select'. Below the search form is a table of replenishment records. A red box highlights the 'Export Excel file' button, and a red arrow points to it.

SN	Machine ID	Cabinet number	Shelf number	Goods name	Measure method	Replenishment quantity	Replenishment staff
1	61260026	1	B11	default	Sale by piece	8	
2	61260026	1	B12	default	Sale by piece	8	
3	61260002	0	A4	default	Sale by piece	0	
4	61260002	0	A9	default	Sale by piece	0	
5	61260002	0	A2	Beef	Sale by piece	0	
6	61260002	0	A3	default	Sale by piece	0	
7	61260002	0	A5	default	Sale by piece	0	
8	61260002	0	A7	default	Sale by piece	6	
9	61260002	0	A1	Beef	Sale by piece	0	

Part IV: Features dictionary



4.9.2 How to check Replenish record (Mobile system)

Login mobile system

<https://moperator.tech.weimi24.com>

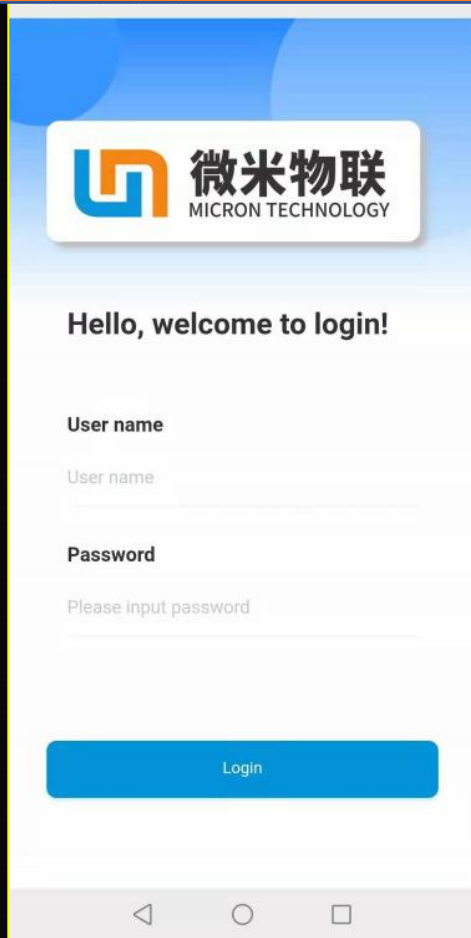

Click "Replenish"

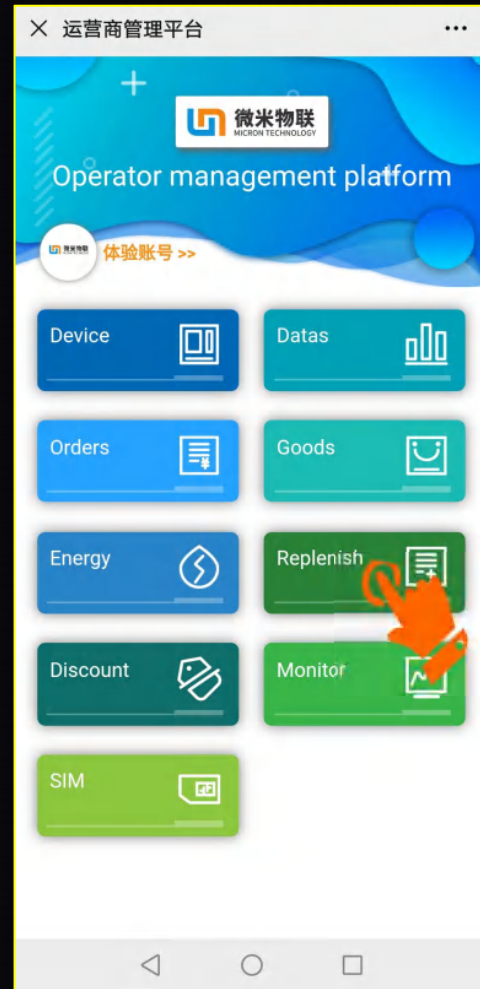

Click "Replenish record"

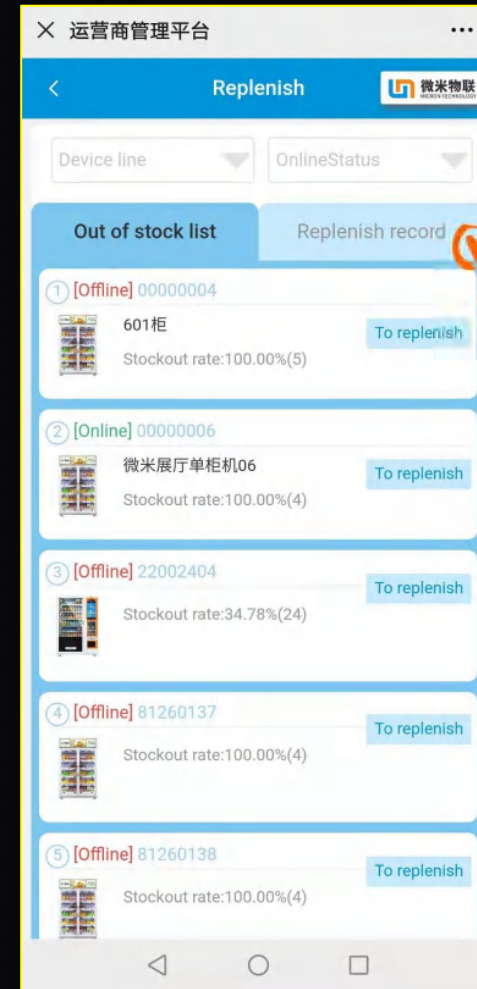

You will see the record for ALL machines under this account

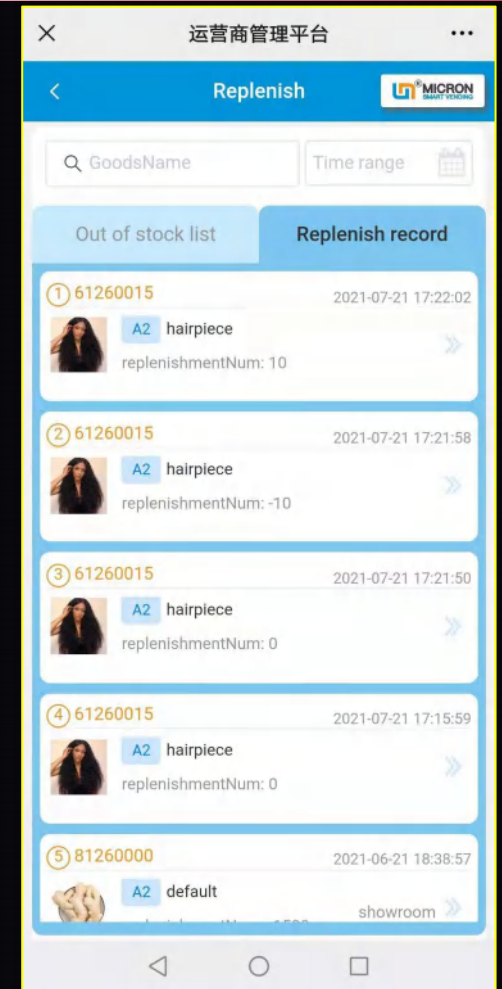

Part IV: Features dictionary



4.9.2 How to check Replenish record (Mobile system)

Click "Device"

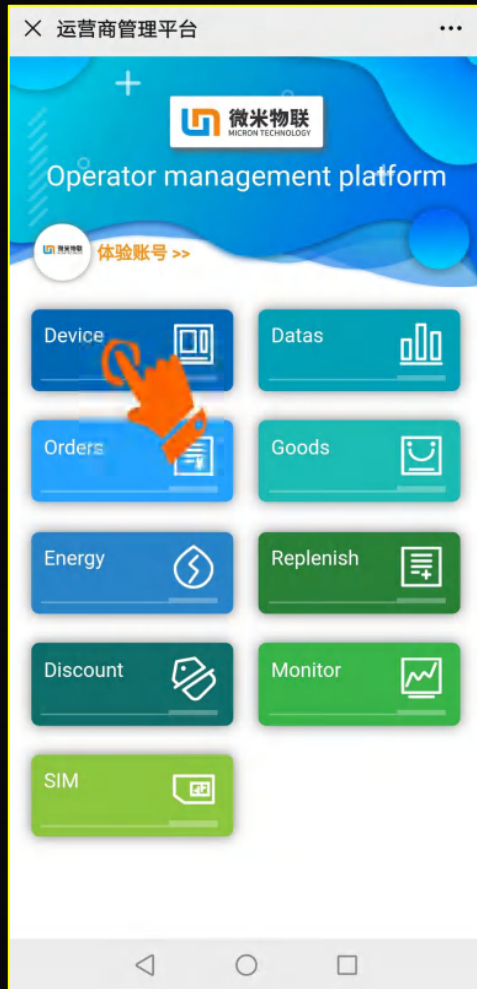

Choose the machine

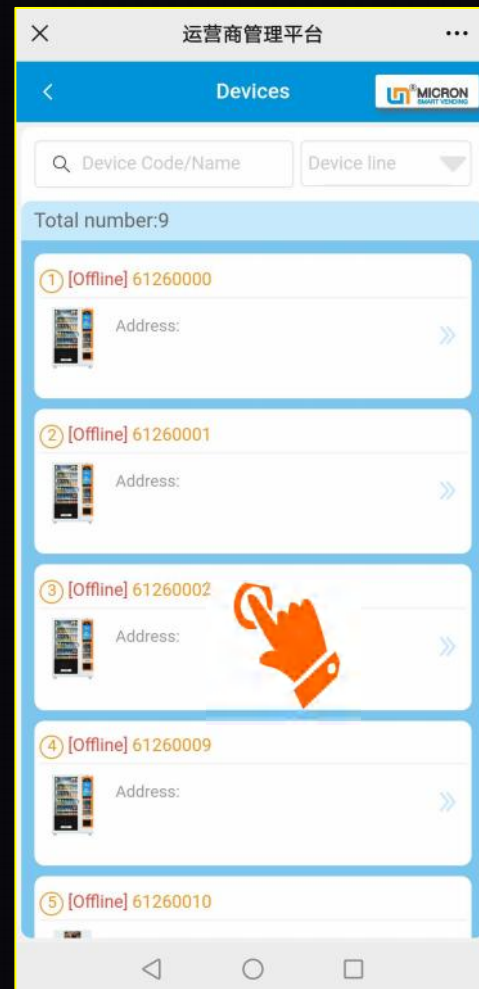

Click "Replenish record"

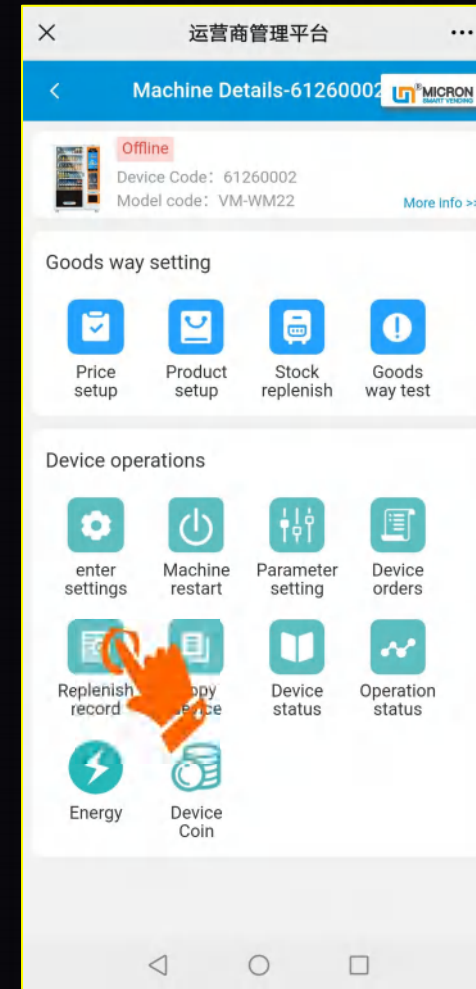

You will see the record for the chosen machine only

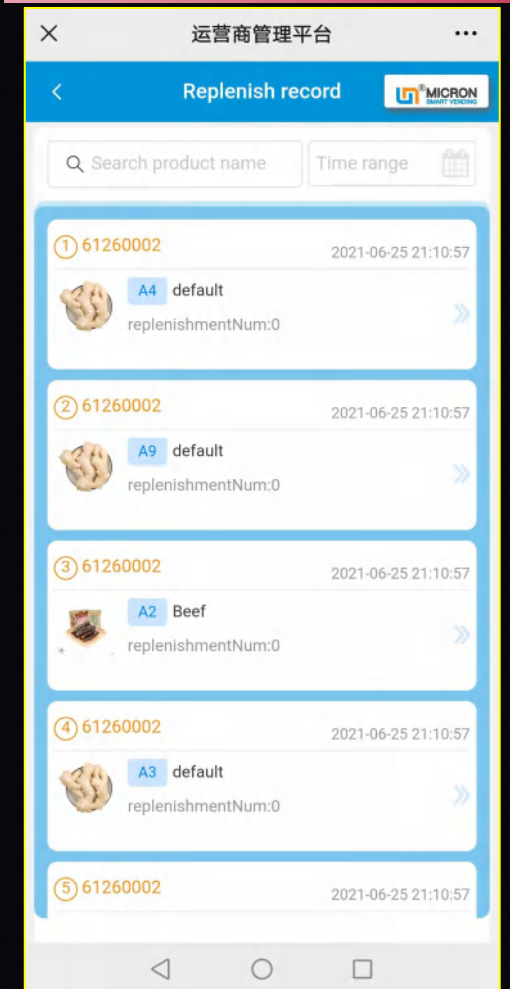



5.1 Installation

5.1.1 Placement of the machine

Try to keep the machine away from following places:

- * direct wind/ rain/ sunlight;
- * high temperature/ humidity;
- * dusty places;
- * moisture or corrosive gas;
- * shaking or unstable ground;

5.1.2 Space for placing the machine

- * refer to the guidelines at the right side;
- * do not block the vents at the back of machine.

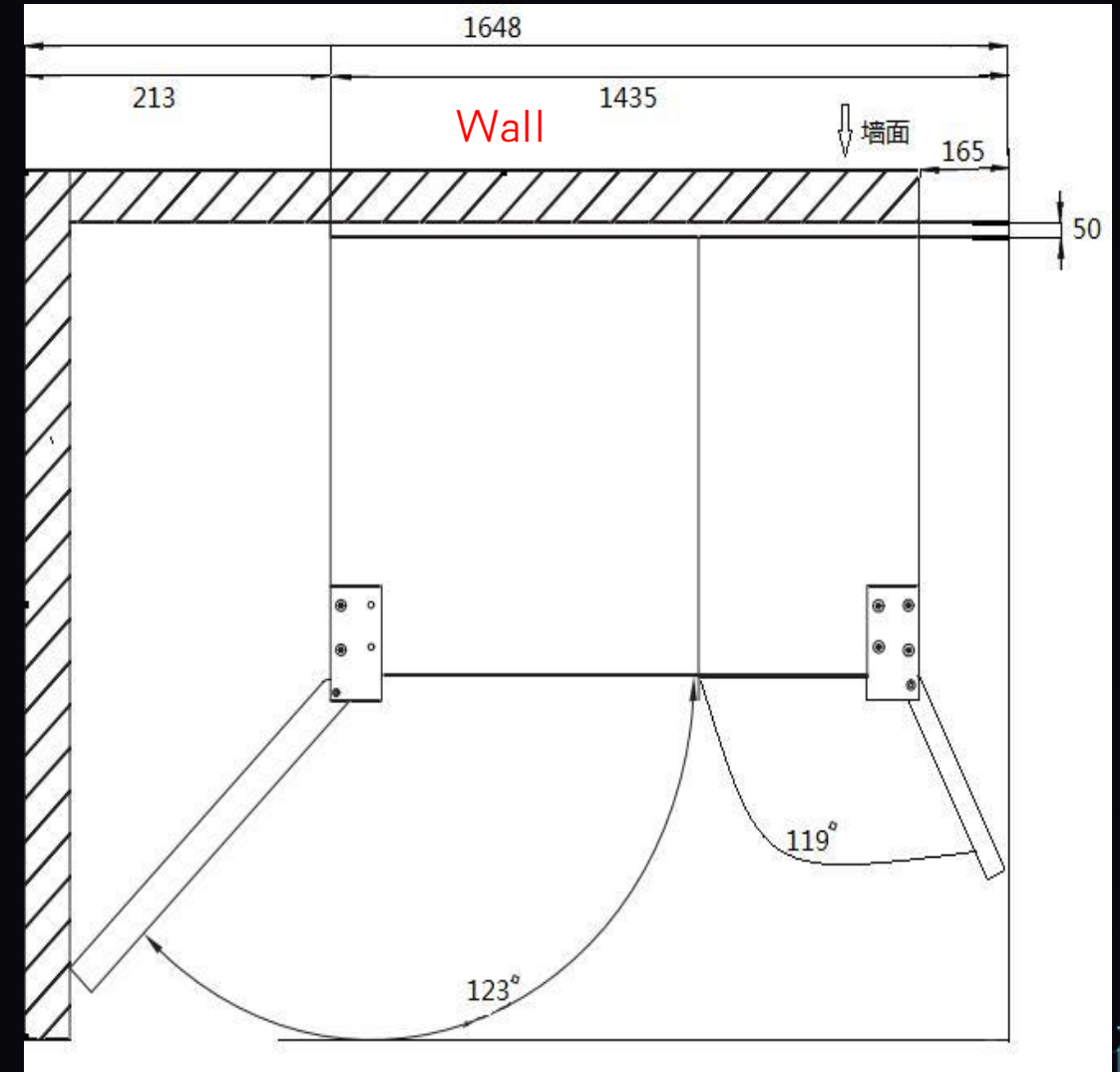



5.1 Installation

5.1.3 Well fixed the wheels of the machine to avoid any accidents from the movement;

5.1.4 Assist with a level ruler, make sure the machine is horizontally fixed on the ground.

5.1.5 If it is installed in the place with the possibility of tilting or rollover, it is necessary to install a fixed bottom plate;





5.2 Open the door lock (Type-1)





5.2 Open the door lock (Type-2)

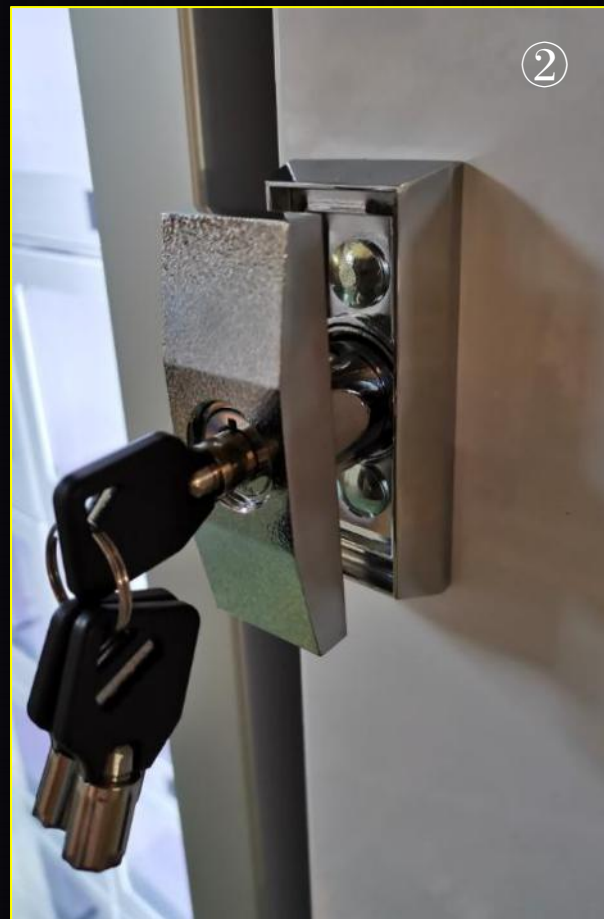
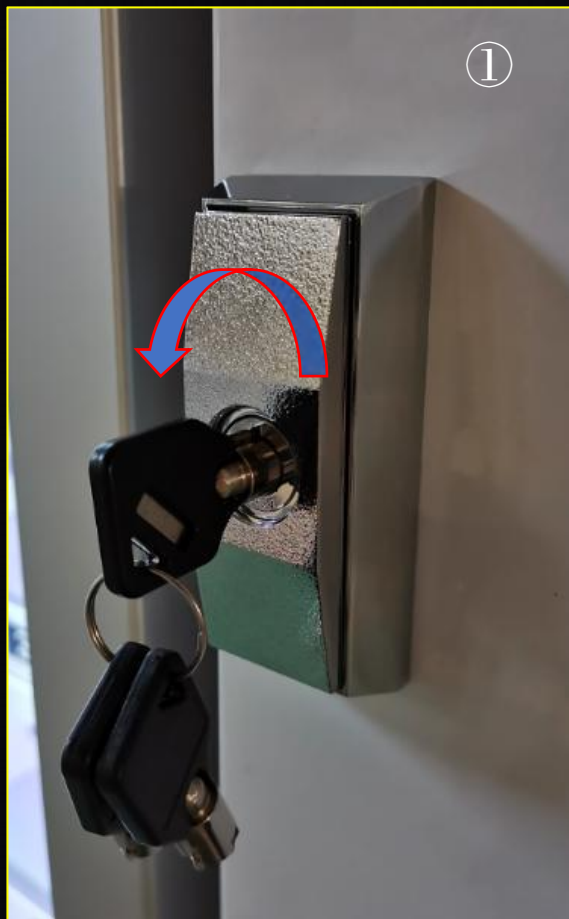



5.3 Electrical control

[How to set temperature?](https://www.youtube.com/watch?v=05RjsfNonu8)
<https://www.youtube.com/watch?v=05RjsfNonu8>

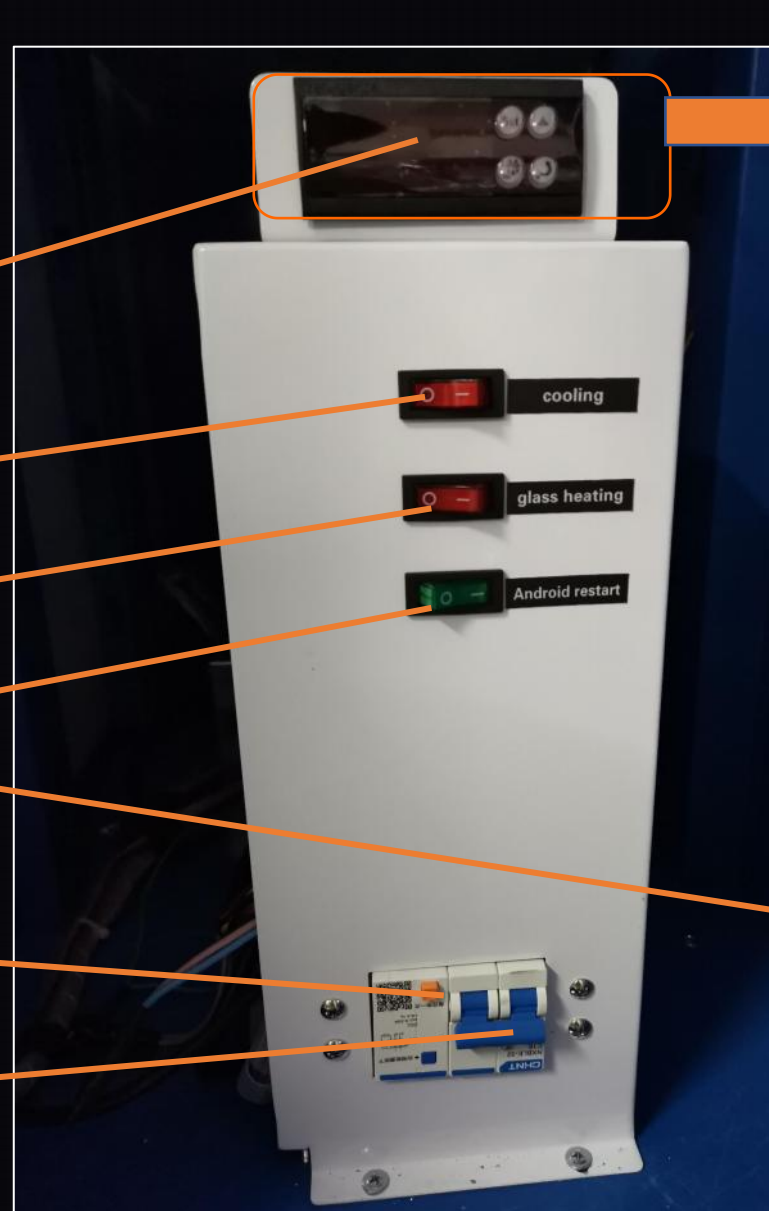

- Temperature control
- Turn on/off cooling system
- Turn on/off the door defog
- Turn on/off Android system
- Leakage relay test button
- Power on/off switch

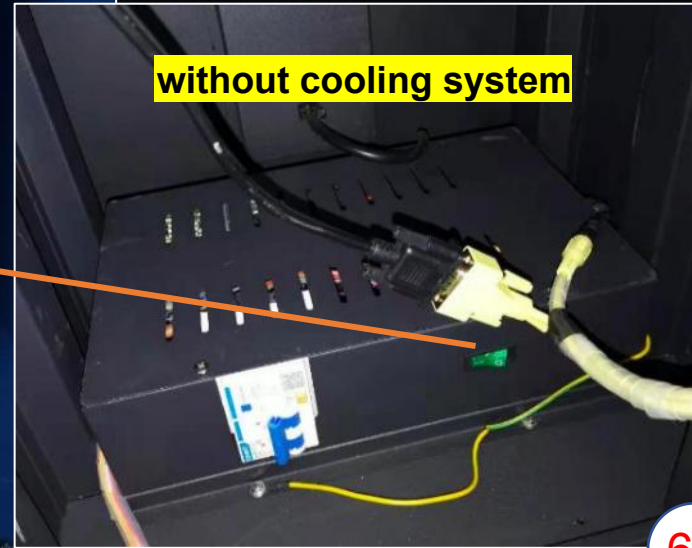



5.4 Power supply

IMPORTANT: For safety purpose, please make sure the power supply has connected the **grounding wire**.

- * When the grounding wire is not connected, **electric shock** may occur.
- * In dry weather, the **key components** inside the machine are very likely to carry static electricity, which will cause the machine not work normally, or even get damaged.
- * Bad grounding will possibly lead to **bad network signal** as well.

5.5 Maintenance of leakage relay

Press the **testing button** at least one time a month to confirm the action of leakage relay. If no action, there is possibility of electric shock.



After testing...
Press down this button,
Turn on the power again.

Part V: Machine installation



5.6 Spiral coils angle adjustment

Pull out the spiral coil slightly (around 1CM), and then rotate the coil clockwise to the position that is suitable for the selling goods.



5.7 Direct-Push type goods tray

 [How to adjust the goods trays \(direct push type\)?](https://www.youtube.com/watch?v=ZW7j6gKYWkk)
<https://www.youtube.com/watch?v=ZW7j6gKYWkk>

5.8 Fill products to machine

 [How to fill the goods to the machine?](https://www.youtube.com/watch?v=UMlxPMjN6F0)
<https://www.youtube.com/watch?v=UMlxPMjN6F0>





TOGETHER, LET'S STEP INTO THE NEW ERA OF UNMANNED RETAIL~

Guangzhou Micron Vending Technology Co., Ltd

Your long-term smart vending machine supplier

Company address:

No.1, Tiantai 1st Road, Huangpu district 510700, Guangzhou, China.

Websites:

www.micronvending.com

www.automatic-vendingmachines.com

Youtube channel:

www.youtube.com/channel/UCCoR1uMn6lztRmoc7EmUFiQ/videos

Catalogue & User manual download

www.micronvending.com/en-download-vending-machine-catalog.html

